

Operating instructions

# ATMOS Twin Record 55

English



## Table of contents

<b>1</b>	<b>Introduction.....</b>	<b>4</b>
1.1	Notes on operating instructions .....	4
1.2	Explanation of pictures and symbols .....	5
1.3	Intended use.....	6
1.4	Function.....	7
1.5	Intended users .....	7
1.6	Scope of delivery .....	8
1.7	Transport and storage .....	8
<b>2</b>	<b>Notes for your safety.....</b>	<b>9</b>
2.1	General safety instructions.....	9
2.2	Danger for users, patients and third parties .....	9
2.1	Avoiding damage to the device .....	11
<b>3</b>	<b>Setting up and starting up .....</b>	<b>12</b>
3.1	Device overview.....	12
<b>4</b>	<b>Operation.....</b>	<b>13</b>
4.1	First start-up .....	13
4.2	PREPARING THE DEVICE .....	13
4.3	Connecting the device to the mains power supply.....	13
4.4	Connecting the DDS secretion canister (ATMOS Twin Record 55 DDS).....	14
4.4.1	Assembly of the DDS secretion canister .....	14
4.4.2	Using the DDS splash protection .....	14
4.4.3	Attaching/remove the DDS canister lid .....	14
4.4.4	Inserting/removing the DDS bacterial filter / oversuction stop .....	14
4.4.5	Attaching, closing, and opening the DDS secretion canister handle.....	15
4.4.6	Attaching/removing the DDS secretion canister.....	15
4.4.7	DDS secretion canister hose holder .....	15
4.4.8	Inserting the DDS hose adapter.....	15
4.4.9	Connecting the suction hose.....	15
4.4.10	Suction .....	16
4.4.11	DDS changeover docking station.....	16
4.4.12	Options.....	17
4.5	Connecting the secretion canister (ATMOS Twin Record 55 with standard rail).....	17
4.5.1	Connecting the bacterial filter .....	17
4.5.2	Connecting the vacuum hose.....	17
4.5.3	Attaching the secretion canister .....	17
4.5.4	Connecting the suction hose.....	18
4.5.5	Serres®, Medi-Vac® secretion canister system, other canister systems .....	18
4.5.6	Secretion canister system.....	18
4.5.7	Double hose connector.....	18
4.5.8	Using an overflow canister .....	19
4.5.9	Using a smoke evacuation filter .....	19
4.5.10	Suction .....	19
4.5.11	Checking the bacterial filter.....	20
4.5.12	Exchanging the secretion canister .....	20
4.5.13	Exchanging Serres®, Medi-Vac® secretion canister system and other secretion canister systems .....	20
4.5.14	Options.....	21

<b>5</b>	<b>Reprocessing.....</b>	<b>22</b>
5.1	Safety instructions for reprocessing.....	22
5.1.1	General safety instructions.....	22
5.1.2	Danger for users, patients and third parties.....	22
5.1.3	Avoiding damage to the device.....	22
5.2	Preparing and completing reprocessing.....	23
5.3	Preparing surfaces.....	23
5.3.1	Overview.....	23
5.3.2	Selecting process chemicals.....	24
5.3.3	Pre-cleaning.....	24
5.3.4	Wipe disinfection.....	24
5.4	Reprocessing the accessories ATMOS Twin Record 55 DDS.....	25
5.4.1	Overview.....	25
5.4.2	Selecting process chemicals.....	25
5.4.3	Secretion canister system.....	26
5.4.4	Hoses.....	27
5.5	Reprocessing the accessories (ATMOS Twin Record 55 with standard rail).....	28
5.5.1	Overview.....	28
5.5.2	Selecting process chemicals.....	29
5.5.3	Secretion canister system.....	29
5.5.4	Hoses.....	30
<b>6</b>	<b>Maintenance and service.....</b>	<b>32</b>
6.1	Periodic tests.....	32
6.2	Function check.....	32
6.3	Sending in the device.....	32
6.4	Reprocessing by the manufacturer.....	32
<b>7</b>	<b>Troubleshooting.....</b>	<b>33</b>
7.1	Troubleshooting.....	33
<b>8</b>	<b>Accessories.....</b>	<b>34</b>
<b>9</b>	<b>Consumables.....</b>	<b>36</b>
<b>10</b>	<b>Disposal.....</b>	<b>37</b>
<b>11</b>	<b>Technical data.....</b>	<b>38</b>
11.1	ATMOS Twin Record 55 DDS.....	38
11.2	ATMOS Twin Record 55 with standard rail.....	39
<b>12</b>	<b>Notes on EMC.....</b>	<b>42</b>
<b>13</b>	<b>Notes.....</b>	<b>43</b>

Further information, accessories, consumables and spare parts are available from:

# ATMOS

MedizinTechnik GmbH & Co. KG

Ludwig-Kegel-Str. 16

79853 Lenzkirch

Germany

E-Mail: [info@atmosmed.de](mailto:info@atmosmed.de)

Web: [www.atmosmed.de](http://www.atmosmed.de)

Phone: +49 7653 689-0

FAX +49 7653 689-190

FAX +49 7653 689-393 (Service)

# 1 Introduction

## 1.1 Notes on operating instructions



These operating instructions contain important instructions on how to operate your product safely, correctly, and effectively.

These operating instructions are designed for training and instructing new operating personnel in the use of the system, and they are also intended for use as a reference manual. This document may only be reprinted, either in part or in whole, with written permission from ATMOS.

**These operating instructions must always be kept available near the product.**



Care, periodic tests, regular cleaning and proper application are essential. They ensure the operational safety and usability of the product.

Maintenance, repairs and periodic tests may only be carried out by persons who have the appropriate technical knowledge and who are familiar with the product. The person must possess the test devices and original spare parts required to carry out these measures.



Read chapter „Notes for your safety“ on page 9 before using the product for the first time. This will help you to avoid potentially dangerous situations.

The product bears the CE marking CE 0124 in accordance with EC Council Directive 93/42/EEC concerning medical devices and meets the basic requirements of Annex I to this directive.

The product complies with all the applicable requirements of Directive 2011/65/EU on the restriction of the use of certain hazardous substances in electrical and electronic equipment (‘RoHS’).

The Declaration of Conformity and our general standard terms and conditions can be viewed on our website at [www.atmosmed.com](http://www.atmosmed.com).







The quality management system at ATMOS has been certified according to international standard EN ISO 13485.

### **These operating instructions are valid for the following devices:**

ATMOS Twin Record 55 DDS	REF 443.0950.0
ATMOS Twin Record 55 with standard rail	REF 443.0960.0













## 1.2 Explanation of pictures and symbols

### In the operating instructions

 <b>DANGER</b>	Warning of a danger that will result in immediate fatal or serious injury. Observe the necessary measures.
 <b>WARNING</b>	Warning of a danger that can cause fatal or serious injury. Observe the necessary measures.
 <b>CAUTION</b>	Warning of a danger that can cause minor injury. Observe the necessary measures.
<b>ATTENTION</b>	Notice of a danger that can damage the product or other objects. Observe the necessary measures.
	Warning of a danger that can cause fatal or serious injury.
	Useful information on the handling of the device.
1.	Action. Proceed step by step.
»	Result of an action.
	Move in this direction, plug in.

### On device and type plate

	Follow operating instructions (blue)
	Observe the operating instructions
	Warning; pay special attention
	This product complies with the relevant requirements of EU Directives.
	This product complies with the relevant requirements of EU Directives.
	Manufacturer
	Manufacturing date
SN	Serial number
REF	Order number

	European Article Number
<b>IP X1</b>	Protection against the penetration of harmful moisture (dripping water)
	Applied part type BF
	Professional disposal
	For single use only (symbol located on consumables)
	Not sterile
	Autoclavable
<b>PATIENT</b>	Connection for suction hose / patient
	Potential equalisation
	Protection class II
	Fuse
	Alternating current
	On, connected to the mains
	Class AP (for use in potentially explosive areas)

### 1.3 Intended use

<b>Main function:</b>	Suction of secretions, blood, serous fluids, rinsing fluids, and for the temporary collection of these fluids.
<b>Medical indications / application:</b>	For all applications where suction is needed, such as in general surgical procedures (e.g., suction of wound cavities, abscesses), the nasopharyngeal cavity, for endoscopy, for suction of secretion or rinsing fluids, and in neurosurgery. For subcutaneous liposuction.
<b>Specification of the main function:</b>	Drainage and temporary collection of bodily secretions. An electric suction pump is used to generate negative pressure. An additional secretion canister must be attached to allow for temporary collection of the drained body fluids.
<b>User profile:</b>	Doctors, medical auxiliaries without restrictions.

<b>Patient groups:</b>	Patients of all ages with and without restrictions.
<b>Application organ:</b>	Natural orifices and openings resulting from a surgical intervention (entire body; human and animals).
<b>Application time:</b>	Short-term use on the patient (< 30 days).
<b>Area of application:</b>	The application site is the clinical, outpatient, medical practice and veterinary field. The device may only be used by persons who have received the relevant training and instruction.
<b>Contraindications:</b>	Not suitable for: <ul style="list-style-type: none"> <li>• Drainage operations in the low-vacuum range (e.g., thoracic or wound drainage)</li> <li>• Use outside the medical sector</li> <li>• Aspiration of flammable, corrosive or explosive substances</li> <li>• Aspiration in potentially explosive atmospheres</li> <li>• Not suitable for use as a vacuum extraction system</li> </ul>
<b>The product is:</b>	Active
<b>Sterility:</b>	Product not sterile.
<b>Single-use product / reprocessing:</b>	The device and parts of the accessories are reusable. Information on reprocessing, cleaning, and disinfection can be found in this document.

## 1.4 Function

The ATMOS Twin Record 55 is a mains-operated surgical suction device in which two ATMOS Record 55 are combined in one shell. The core piece are two high-performance, maintenance-free diaphragm pumps. These generate vacuum in the suction hose and secretion canister system, which assists in suctioning and collecting secretions. The final vacuum and thus the desired suction capacity can be set individually and independently of one another using two vacuum regulators with vacuum gauges.

Several secretion canisters of different sizes are available for use with the system.

The reusable secretion canister can be mounted to the ATMOS Twin Record 55 DDS via the Direct-Docking-System. The user can connect the suction hose directly. A hydrophobic bacterial filter located in the canister lid prevents bacteria and liquids from penetrating the pump. This protects the device against oversuction. The inlet located in the hose connection prevents foaming in the secretion canister and therefore ensures a longer filter life.

With the ATMOS Twin Record 55 with standard rail, the various sizes of secretion canisters are attached directly to the standard rail on the device. Two bacterial filters in the vacuum hose from the secretion canister to the device prevents secretion from being sucked into the pump.

## 1.5 Intended users

May only be used by trained professionals in supervised and medical operation.

## 1.6 Scope of delivery

<b>Name</b>	<b>REF</b>
<b>ATMOS Twin Record 55 DDS</b>	<b>443.0950.0</b>
1x basic device DDS	
1x power cable 5 m	008.0629.0
1x hose holder, double	320.0611.0
1x operating instructions	GA1GB.210001.0
<b>ATMOS Twin Record 55 with standard rail</b>	<b>443.0960.0</b>
1x basic device with standard rail	
1x power cable 5 m	008.0629.0
1x hose holder, double	320.0611.0
2x hydrophobic bacterial and viral filter	443.0738.0
2x suction hose (silicone), Ø 7 mm, L = 0.7 m	006.0008.0
2x suction hose (silicone), Ø 6 mm, L = 2 m	000.0361.0
2x suction hose (silicone), Ø 10 mm, L = 2 m	000.0243.0
1x operating instructions	GA1GB.210001.0

### **Not included in the scope of delivery:**

- Secretion canister system
- Safety canister
- Suction hose (for the ATMOS Twin Record 55 DDS)
- DDS bacterial filter (for the ATMOS Twin Record 55 DDS)

## 1.7 Transport and storage

Only transport the product in a shipping carton that is padded and offers sufficient protection.

If damage occurs during transport:

1. Document and report damages in transit.
2. Send the device to ATMOS see chapter „6.3 Sending in the device“ on page 32.

### **Ambient conditions for transport and storage:**

- Temperature: -30...+50 °C
- Relative humidity: 5...90% without condensation
- Atmospheric pressure: 700...1060 hPa



## 2 Notes for your safety

### 2.1 General safety instructions

Only a fully functional product meets the safety requirements of users, patients and third parties. Therefore, please observe the following instructions on your product:

Please read and pay attention to the safety instructions prior to using the product.

### 2.2 Danger for users, patients and third parties

#### WARNING

##### **Choking hazard for children due to accessories!**

Children can strangle themselves or choke on small parts.

- Keep children away from hoses and connection cables.
- Keep children away from swallowable small parts. Examples of swallowable small parts are the fingertip and sealing ring.

#### CAUTION

##### **Explosion and fire hazard!**

There is a risk of burns and injuries.

- Never suction any explosive, flammable or corrosive gases or liquids. Please observe the intended use in chapter „1.3 Intended use“ on page 6.
- Never operate the product in potentially explosive areas or in areas that are oxygenated.
- Only use original accessories and original spare parts from ATMOS.

#### WARNING

##### **Your patient can be severely injured.**

Avoid improper use.

- The product may only be used by medically trained persons who have been instructed in the handling of the medical suction system.
- The product may only be used by qualified personnel in supervised operation.
- Please select the vacuum according to the patient and the application.
- Observe the valid guidelines.
- Always set up the device in such a way that the operating elements are in clear view and within easy reach of the operator. The device must be set up on a stable, level surface.

**⚠ WARNING**

**Ensure that the device is always functional and ready for use.**

Your patient may suffocate.

- Before connecting the device it needs to be checked whether the requested mains voltage of the device matches the mains voltage of the mains power supply.
- Position the device in an easily accessible location and keep access free.
- Make sure that the power cable is functional. Replace defective accessories immediately.
- Remove the transport protection on the bottom of the device prior to first use.
- ATMOS recommends always having another suction device ready at hand. Thus suction is available even in the event of device failure.

**⚠ WARNING**

**Risk of infection due to pathogens on the product!**

Deadly diseases can be transmitted.

- Always wear disposable gloves if you could come into contact with secretion.
- Always wear disposable gloves when using the product.
- Never use components marked with ⓧ more than once. These components are intended for single use only.
- Sterile-packed parts may only be used if the packaging is undamaged.
- Do not operate the device without a bacterial filter.
- A suction catheter, suction attachment or suction instrument must always be connected to the suction hose. The suction hose must never come into direct contact with the suction area.
- Clean and disinfect the product after every use.
- Clean and disinfect the product according to the operating instructions.
- The product must not be used following oversuction.

**⚠ WARNING**

**Tripping hazard due to cables.**

Injuries are possible.

- Lay connecting power cables properly.

**⚠ WARNING**

**Electric shock due to unsuitable mains connection, incorrect handling of the product, or damaged product components**

Burns, cardiac arrhythmias and even fatal injury are possible.

- Prior to each use, check for damage to the device and the power cable. Do not operate the device if you notice any damage. In this case, clean and disinfect the device and send it to ATMOS for repair.
- Disconnect the device from the mains power supply before cleaning or disinfecting it.
- You can only disconnect the device from the power supply by pulling out the power plug.
- Position the device in such a way that you can easily disconnect it from the mains power supply at any time.
- Only connect the device to a mains power supply with a protective conductor.
- Never touch the plug or power cable with wet hands.
- Use the power cable only in dry surroundings. The surroundings must be non-conductive.
- Ensure that no liquid enters the device. If liquid gets into the device, operation of the device must cease immediately. In this case, clean and disinfect the device and send it to ATMOS for repair.
- Only use proper power cables and extension cords.
- Never touch the device's interfaces and the patient at the same time!
- Use only original accessories and original spare parts from ATMOS.
- Please pay attention to the period tests in chapter 6.0 „Maintenance and service“.
- Assembly, new settings, alterations, extensions and repairs may only be carried out by authorised persons.
- Do not modify the device without the manufacturer's permission.

## 2.1 Avoiding damage to the device

**ATTENTION**

**Storage and operation in an unsuitable environment.**

The product can become damaged.

- Please observe the ambient conditions for transport, storage and operation.
- After transportation of the device at low temperatures and prior to first start-up it should be kept at room temperature for at least six hours. If the device is not acclimatized it may not be used as damage to the diaphragms of the pump could occur.

## 3 Setting up and starting up

### 3.1 Device overview

#### Front view ATMOS Twin Record 55 DDS



- ❶ Vacuum gauge I
- ❷ Vacuum regulator I
- ❸ ON/OFF switch I
- ❹ ON/OFF switch II
- ❺ Vacuum gauge II
- ❻ Vacuum regulator II
- ❼ Hose holder
- ❽ DDS changeover docking station
- ❾ Single docking station
- ❿ Connection for the foot switch (foot controller for switching the left pump ON or OFF)

#### Front view ATMOS Twin Record 55 with standard rail



- ❶ Vacuum gauge I
- ❷ Vacuum regulator I
- ❸ ON/OFF switch I
- ❹ ON/OFF switch II
- ❺ Vacuum gauge II
- ❻ Vacuum regulator II
- ❼ Hose holder
- ❽ Connection piece I
- ❾ Connection piece II
- ❿ Standard rail
- ⓫ Single docking station
- ⓬ Connection for the foot switch (foot controller for switching the left pump ON or OFF)

#### Rear view



- ❶ Connection for potential equalisation
- ❷ Equipment safety fuse
- ❸ Mains supply

## 4 Operation

### 4.1 First start-up

- ☞ Observe the safety instructions prior to initial start-up!
- ☞ Remove the transport protection on the bottom of the device by loosening the two Allen screws marked in red.
- ☞ The transport protection screws must be inserted again before sending back the device.
- ☞ After transporting the device at low temperatures, it should be kept at room temperature for at least six hours before initial start-up; otherwise, the device may not be operated.

### 4.2 Preparing the device

Prior to first operation peruse the safety information in chapter „2 Notes for your safety“ on page 9. Damaged pump diaphragms due to cold temperatures during transport.

1. In case the device was transported at temperatures below 0°C: Keep the device at room temperature for at least 6 hours before proceeding with the next steps.
2. Check the device for any transport damage.
3. If the device is damaged: Document and report the transport damage. Send in the device to ATMOS „6.3 Sending in the device“ on page 32

### 4.3 Connecting the device to the mains power supply

A medical isolation transformer according to EN 60601-1 is required if several devices are connected over one common power supply.

This must correspond to the power consumption of all devices to be connected and be equipped with an insulation monitor or a comparable safety device.

1. ATMOS recommends: Connect the potential equalization connection (1) to the potential equalisation in the examination room.
2. Check whether the voltage and nominal frequency of the mains power supply match the information on the device.
3. Connect the device to the mains (2).
4. The device is now ready for use.

## 4.4 Connecting the DDS secretion canister (ATMOS Twin Record 55 DDS)

### 4.4.1 Assembly of the DDS secretion canister



- ❶ DDS secretion canister handle
- ❷ DDS bacterial filter
- ❸ DDS hose adapter
- ❹ DDS canister lid
- ❺ DDS splash protection
- ❻ DDS secretion canister

### 4.4.2 Using the DDS splash protection



1. Attach the splash protection to the pipe connection in the DDS canister lid.
- ☞ The splash protection protects the DDS bacterial filter from becoming wetted prematurely by liquids and/or foam formation.

### 4.4.3 Attaching/removing the DDS canister lid

1. **Place** the DDS secretion canister on a firm surface and **set** the DDS secretion canister lid horizontally on it (the lid cannot be turned incorrectly).
2. Gently **press** the DDS canister lid with both hands onto the secretion canister as far as it will go.
3. To **open** the DDS canister lid, hold it on the reinforcement bars of the mounting fixture and then pull the DDS canister lid upwards by reaching into the opening for the filter.

### 4.4.4 Inserting/removing the DDS bacterial filter / oversuction stop



The DDS bacterial filter / oversuction stop are disposable products.

- ☞ Prior to each use check whether the DDS bacterial filter / oversuction stop are dry and clean. Replace the DDS bacterial filter with a new filter if it is discoloured, contaminated or oversucked.
1. Insert the bacterial filter onto the DDS secretion canister handle.

#### 4.4.5 Attaching, closing and opening the DDS secretion canister handle



1. To **attach** the DDS secretion canister handle, insert it into the grooves of the canister lid (with the locking latches open).
2. To **close** the DDS secretion canister handle, clip the locking latches under the canister rim. Then press the clips towards the secretion canister until they click into place.
3. To **open**, pull the clips outwards and remove the locking latches from under the canister rim.

#### 4.4.6 Attaching/removing the DDS secretion canister



1. To attach the DDS secretion canister, allow it to slide vertically downwards into the mounting fixture.
2. To remove the DDS secretion canister, lift it straight up.

#### 4.4.7 DDS secretion canister hose holder



1. If using a DDS secretion canister hose holder, attach it between the canister lid and the hose adapter.

#### 4.4.8 Inserting the DDS hose adapter



1. Insert the DDS hose adapter (Ø 6 or 10mm) into the 'Patient' opening on the DDS canister lid.
  2. Turn it slightly and press it down.
- ☞ The adapter can be removed again by turning it slightly.

#### 4.4.9 Connecting the suction hose



- ☞ Connect the suction hose to the already inserted hose adapter.

#### 4.4.10 Suction



1. Please ensure that the following parts have been reprocessed before treating a new patient:
    - Suction hose including hose-rinsing aperture or suction instruments
    - DDS secretion canister system including DDS canister lid and DDS hose adapter
  2. Prior to each use, check whether the DDS bacterial filter was inserted during cleaning and disinfection.
  3. Replace the bacterial filter with a new filter if it is discoloured, contaminated or oversucked.
  4. Switch on the device.
  5. Close the suction hose and set the desired vacuum.
  6. Connect the suction catheter, hose-rinsing aperture, or suction instruments.
- ☞ Observe the liquid level in the secretion canister during suction. The DDS bacterial filter prevents liquid from being sucked into the pump. Nevertheless, the secretion canister should be emptied or replaced when it is 2/3 full (including foam crown).
- ☞ If liquid has been sucked into the pump despite the bacterial filter, the device may not be operated again until it has been checked by an authorised service partner.

#### 4.4.11 DDS changeover docking station



- ☞ The maximum load of the station is 15 kg; higher loads may damage the device!

The DDS changeover docking station is used if two secretion canisters are required. The changeover lever serves to switch the vacuum to the secretion canister being used. When removing or attaching a secretion canister, switch the lever towards the second secretion canister.



## 4.4.12 Options

### Foot switch, REF 443.0755.0

Pneumatically explosion-proof switch for switching the device on and off.

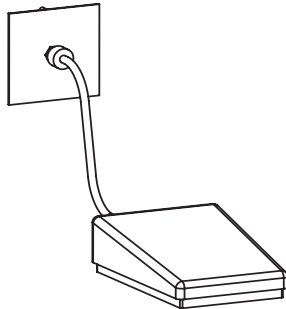

1. Connect the foot switch.
2. Set the main switch in the control panel to foot switch operation (OFF).
3. Pressing the foot switch turns the device on.
4. Pressing the foot switch again turns the device off.
5. If the main switch in the control panel is set to continuous operation (ON), the foot switch produces **no** effect.

## 4.5 Connecting the secretion canister (ATMOS Twin Record 55 with standard rail)

### 4.5.1 Connecting the bacterial filter



- Insert the bacterial filter with the short hose onto the connection piece on the device.
- ☞ Pay attention to the correct flow direction on the bacterial filter. The type label must point forwards.

### 4.5.2 Connecting the vacuum hose



- Connect the vacuum hose to the bacterial filter.

### 4.5.3 Attaching the secretion canister

1. Attach the secretion canister to the standard rail.
2. Connect the canister lid or double hose connector to the bacterial filter with the hose.
3. First make sure that the secretion canister is attached in the front. If additional secretion canisters are required, they can be attached laterally.

#### 4.5.4 Connecting the suction hose



- Attach the suction hose to the angled connection.

#### 4.5.5 Serres®, Medi-Vac® secretion canister system, other canister systems

- ☞ Observe the operating instructions by the manufacturer of the corresponding canister system.
- ☞ Do not operate the device without a bacterial filter.

#### 4.5.6 Secretion canister system

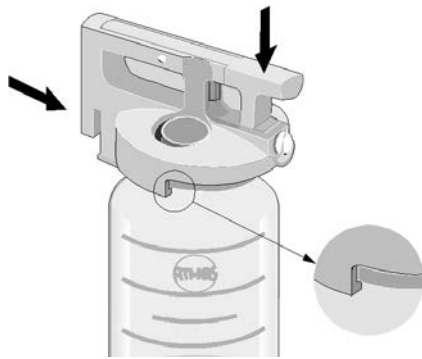

- Slide the canister lid over the secretion canister (make sure the lid edge is over the edge of the canister) and press the locking handle downwards until it engages.
- The canister lid must tightly seal the secretion canister so that the vacuum required can build up within.

#### 4.5.7 Double hose connector



Before inserting the double hose connector, check whether the float ball for the overflow safety moves freely. Then insert the double hose connector into the canister lid. Make sure that it fits tightly.

- ❶ Connection for vacuum hose
- ❷ Connection for suction hose
- ❸ Float ball for the overflow safety

#### 4.5.8 Using an overflow canister



If the bacterial filter becomes frequently blocked, ATMOS recommends integrating an additional overflow canister (REF 444.0646.0) between the secretion canister and the bacterial filter. This absorbs moisture and foam bubbles occurring.

An additional DDS bacterial filter can be used in the overflow canister. Replace the bacterial filter (REF 340.0054.0) with a new filter if it is discoloured, contaminated or oversucked. When the filter is used regularly, a filter change is recommended after 14 days at the latest.

#### 4.5.9 Using a smoke evacuation filter

According to the intended use, the device is used to suction liquids and pieces of tissue. In conjunction with the use of laser, HF or radiosurgical devices, surgical smoke is generated and does not remain in the secretion canister, but is drawn with the air flow in the direction of the pump and can quickly block the bacterial filter for microbiological protection as well as the overflow protection. To increase the service life of the bacterial filter, an activated charcoal filter (REF 008.0758.0) or a specific smoke evacuation filter (HM 57524928) can be placed in front of it. This filters the aerosols / ultra-fine particles out of the air stream and protects the bacterial filter.

**ATTENTION! THE SMOKE EVACUATION FILTER DOES NOT REPLACE THE BACTERIAL FILTER!**

The smoke evacuation filter, however, prevents a premature decrease in suction performance by blocking the bacterial filter.

#### 4.5.10 Suction

1. Please ensure that the following parts have been reprocessed before treating a new patient:
    - Suction hose including hose-rinsing aperture or suction instruments
    - Secretion canister including canister lid and double hose connector
    - Vacuum hose
  2. Prior to each use please check whether the bacterial filter has to be replaced.
  3. Replace the bacterial filter with a new filter if it is discoloured, contaminated or oversucked.
  4. Switch on the device.
  5. Close the suction hose and set the desired vacuum.
  6. Connect the suction catheter, hose-rinsing aperture, or suction instruments.
- ☞ Observe the liquid level in the secretion canister during suction. The mechanical overflow protection and the bacterial filter prevent liquid from being sucked into the pump. Nevertheless, the canister should be emptied or replaced when it is 2/3 full (including foam crown).
  - ☞ If liquid has been sucked into the pump despite the overflow protection and bacterial filter, the device may not be operated again until it has been checked by a authorized service partner

#### 4.5.11 Checking the bacterial filter

##### ATTENTION

The bacterial filter is a disposable product and cannot be autoclaved or disinfected.

- Set the vacuum regulator to "max".
  - As soon as the vacuum gauge shows a vacuum value higher than -0.3 bar, while the suction hose is open, the filter must be replaced.
  - To do this, remove the suction connections on the bacterial filter and insert the new bacterial filter. Pay attention to the correct flow direction.
  - Dispose of the used bacterial filter immediately.
- ☞ Always have some spare filters ready to hand!

#### 4.5.12 Exchanging the secretion canister

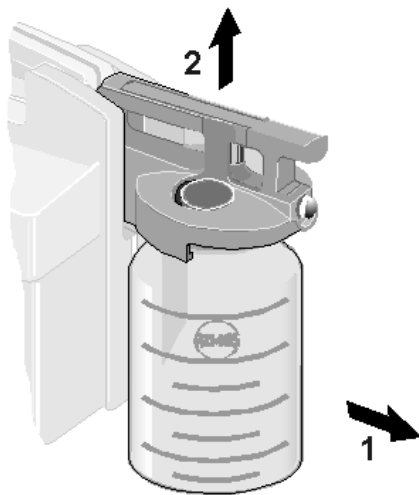

1. Stop the suction process by switching off the pump.
2. Remove the double hose connector from the full secretion canister. If you have attached a second canister, insert it and continue the suction process.
3. To remove the secretion canister, first tip it slightly away from the device (1) and then pull it upwards (2).
4. Now either empty it or replace it with a new secretion canister. To open the clamping bracket, put the secretion canister down and press the release button. Dispose of the suction material properly.
5. After use, switch off the device and clean the device and accessories as described in the operating instructions.

#### 4.5.13 Exchanging Serres®, Medi-Vac® secretion canister system and other secretion canister systems

- ☞ Observe the operating instructions by the manufacturer of the corresponding canister system.

## 4.5.14 Options

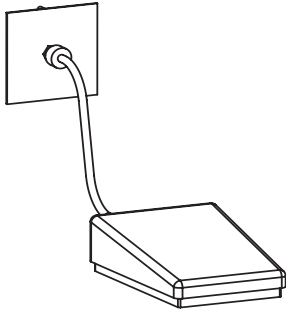

### Foot switch, REF 443.0755.0

Pneumatically explosion-proof switch for switching the device on and off.

1. Connect the foot switch.
2. Set the main switch in the control panel to foot switch operation (OFF).
3. Pressing the foot switch turns the device on.
4. Pressing the foot switch again turns the device off.

If the main switch in the control panel is set to continuous operation (ON), the foot switch produces no effect.

## 5 Reprocessing

### 5.1 Safety instructions for reprocessing

#### 5.1.1 General safety instructions

We recommend that you always document all maintenance work and part replacements in writing.

It is the responsibility of the user to ensure that the required results of cleaning and disinfection are achieved. Generally, validation and routine monitoring of the procedure will be necessary.

Reprocessing may only be carried out by persons who have the necessary expertise. The person must have the necessary equipment to carry out these measures.

#### 5.1.2 Danger for users, patients and third parties

##### **Risk of infection due to unsuitable medical aids.**

Deadly diseases can be transmitted.

- Always wear your own personal protective gear. The protective gear consists of protective gloves, protective clothing, goggles, and mouth and nose protection for all steps in which the product components are still contaminated.
- Only use aids that can be easily reprocessed or ones that are disposable products.

##### **Risk of infection due to unsuitable reprocessing.**

Deadly diseases can be transmitted.

- Make sure that all areas of the accessories can be reached easily.
- Use only suitable load carriers for mechanical reprocessing. This especially applies to accessories with hollow spaces and lumina that are hard to reach.
- Make sure that air bubbles do not form in the hollow spaces and lumina of accessories when placing them in processing solutions.

#### 5.1.3 Avoiding damage to the device

##### **Damage to the device due to cleaning with fixatives.**

Stains and soiling cannot be removed permanently.

- Do not use aldehydes before and during cleaning.
- Do not expose the product to temperatures > 40 °C / 104 °F before and during cleaning.

##### **Unsuitable aids.**

- ☞ Follow the corresponding operating instructions of all aids and devices used.

### Unsuitable cleaning agents and disinfectants.

The product can become damaged.

- Do not use any process chemicals containing the following ingredients **on plastic parts**:
  - Chloramides or phenol derivatives
- Do not use any process chemicals containing the following ingredients **on stainless steel**:
  - Organic or inorganic bases
  - Alkaline solutions

### Incorrect mechanical cleaning and disinfection.

Corrosion due to moisture.

- Remove the products immediately after the programme is finished.

## 5.2 Preparing and completing reprocessing

### Prior to reprocessing

1. Disassemble the product into the following items for reprocessing:
  - Device
  - Hoses
  - Secretion canister system

### After reprocessing

1. Perform a function check.

## 5.3 Preparing surfaces

### 5.3.1 Overview

Surface	After each use	After each patient	Daily	Weekly	Every 14 days	Monthly	Pre-cleaning	Wipe cleaning	Wipe disinfection	Spray disinfection	Remarks
Housing	X						X	X			

### 5.3.2 Selecting process chemicals

Follow the manufacturer's instructions for the process chemical.

Cleaning agent (manufacturer)	Active ingredients in 100 g	Type	Housing
<b>Disinfection</b>			
Green & Clean SK (Metasys)	<1 g dialkyldimethylammonium chloride, <1 g alkyldimethylethylbenzylammonium chloride, <1 g alkyldimethylbenzylammonium chloride	Foam Ready to use	x
Dismozon® plus (Bode Chemie)	95.8 g magnesium monoperoxyphthalate hexahydrate	Granulate	x
Kohrsolin® FF (Bode Chemie)	5 g glutaral, 3 g benzyl-C12-C18-alkyldimethylammonium chloride, 3 g didecyldimethylammonium chloride	Liquid concentrate	x
Kohrsolin® extra (Bode Chemie)	14.1 g (ethylenedioxy)dimethanol, 5 g glutaral, 8 g didecyldimethylammonium chloride	Liquid concentrate	x
Perform® (Schülke & Mayr)	45 g pentapotassium bis(peroxymonosulphate) bis(sulphate)	Powder	x
Mikrobac® forte (Bode Chemie)	19.9 g benzyl-C12-18-alkyldimethylammonium chloride, 5 g N-(3-aminopropyl)-N-dodecylpropane-1,3-diamine	Liquid concentrate	x
Bacillo® 30 Foam (Bode Chemie)	14 g ethanol, 10 g propane-2-ol, 6 g propane-1-ol, 0.5 g n-alkyl-aminopropyl-glycine	Foam, ready to use	x
Incidin® Active (Ecolab)	Peracetic acid	Powder	x
mikrozid® sensitive wipes (Schülke & Mayr)	0.26 g alkyl(C12-16)dimethylbenzylammonium chloride, 0.26 g didecyldimethylammonium chloride, 0.26 g alkyl(C12-14)ethylbenzylammonium chloride	Wipes	x

### 5.3.3 Pre-cleaning

1. Disconnect the device from the mains.
2. Clean the surface evenly with a suitable cloth and clear water. Pay particular attention to hard-to-reach areas.
  - » No more residue is visible.

### 5.3.4 Wipe disinfection

Follow the manufacturer's instructions for the process chemical.



## 5.4 Reprocessing the accessories ATMOS Twin Record 55 DDS

### 5.4.1 Overview

Accessory	Disposable product	Max. reprocessing cycles	After each use	After each patient	Daily	Weekly	Every 14 days	Monthly	Pre-treatment	Pre-cleaning	Manual cleaning and disinfection	Mechanical cleaning and disinfection	Sterilisation
<b>Secretion canister system</b>													
• DDS secretion canister <sup>2</sup>		60	x						x	x		x	x
• DDS canister lid <sup>2</sup>		60	x						x	x		x	x
☞ DDS secretion canister handle													
☞ DDS splash protection													
☞ DDS hose adapter													
• DDS bacterial filter <sup>1</sup>	x <sup>3</sup>												
<b>Hoses</b>													
• Suction hose		60	x						x	x		x	x

<sup>1</sup> Replace the DDS bacterial filter if it is discoloured or soiled, or if oversuction has occurred; see chapter 4.4.4.

<sup>2</sup> If an accessory shows any visible damage, please replace it.

<sup>3</sup> Replace the DDS bacterial filter at every cleaning or when disinfecting the DDS secretion canister system.

### 5.4.2 Selecting process chemicals

Follow the manufacturer's instructions for the process chemical.

Cleaning agent (manufacturer)	Active ingredients in 100 g	Type	Secretion canister system	Hoses
<b>Cleaning agents - Mechanical reprocessing</b>				
neodisher® MediClean forte (Dr. Weigert)	<5% non-ionic and anionic surfactants, enzymes	Liquid concentrate		x
neodisher® An (Dr. Weigert)	<5% nonionic surfactants, >30% phosphates, enzymes	Powder	x	
<b>Neutraliser</b>				
neodisher® Z (Dr. Weigert)	<5% non-ionic and anionic surfactants, enzymes	Liquid concentrate	x	

### 5.4.3 Secretion canister system

#### Characteristics

The accessories have the following hard-to-reach areas:

- Double hose connector (lumina)
- Secretion canister lid complete (hollow spaces)

Take particular care when reprocessing hard-to-reach areas.

<p><b>Pre-treating at the site of use</b></p> <p>Flushing: 60 s Rinsing: 60 s</p>	<ol style="list-style-type: none"> <li>1. Empty the canister.</li> <li>2. Clean the accessories under cold, running water.</li> <li>3. Rinse the hollow spaces and lumina of the accessories thoroughly under running water.</li> </ol> <p>» No more residue is visible.</p>
<p><b>Collecting and transporting</b></p>	<ol style="list-style-type: none"> <li>1. Label any damaged accessories.</li> <li>2. Place the accessories in a canister.</li> <li>3. Transport the canister to the reprocessing site.</li> </ol>
<p><b>Disassembly</b></p>	<p>See chapter „3 Setting up and starting up“ on page 12.</p> <p>» Discard disposable products.</p>
<p><b>Pre-cleaning</b></p> <p>Flushing: 1x / 30 s Rinsing: 60 s</p> <p>Brush: Round brush • Diameter: 7 / 11 / 15 mm • Material: Nylon • Characteristics: With angled head</p>	<p>☞ Pre-cleaning is only necessary for mechanical cleaning and disinfection.</p> <ol style="list-style-type: none"> <li>1. Make the following hollow spaces accessible: <ul style="list-style-type: none"> <li>• Double hose connector</li> <li>• Entire secretion canister lid</li> </ul> </li> <li>2. Make the following lumina accessible: <ul style="list-style-type: none"> <li>• Double hose connector</li> </ul> </li> <li>3. Clean the accessories evenly with a suitable brush under running water.</li> <li>4. Rinse the hollow spaces and lumina of the accessories thoroughly under running water.</li> </ol>
<p><b>Mechanical cleaning and disinfection</b></p> <p>Pre-rinse: 1 min Clean: 5 min 50 °C / 122 °F Neutralise: 2 min Intermediate rinse: 1 min Disinfect: 5 min 93 °C / 199 °F Dry: 12 min 110 °C / 230 °F</p>	<ol style="list-style-type: none"> <li>1. Empty the secretion canister.</li> <li>2. Clean and disinfect using a suitable programme: <ul style="list-style-type: none"> <li>• Pre-rinse with cold water</li> <li>• Cleaning with cleaning agent</li> <li>• Neutralisation with neutralising agent</li> <li>• Intermediate rinse with softened, cold water</li> <li>• Disinfection with suitable disinfectant and demineralised water</li> <li>• Drying</li> </ul> </li> </ol> <p>Cleaning and disinfection device: • In accordance with EN ISO 15883-1 Programme: • Miele Vario TD Adapter: • Adapter Miele E329</p>

<b>Checking and maintaining</b>	<ol style="list-style-type: none"> <li>1. Check whether reprocessing was successful with a suitable light magnifier. <ul style="list-style-type: none"> <li>• Free of particles and organic material</li> </ul> </li> <li>2. Dispose of damaged accessories or have them repaired.</li> </ol>
<b>Assembly</b>	Not necessary.
<b>Function check</b>	Not necessary.
<b>Packaging</b>	<ol style="list-style-type: none"> <li>1. Label the accessories.</li> <li>2. Pack the accessories using a packaging system according to DIN EN ISO 11607.</li> </ol>
<b>Sterilisation</b> Prefractionated 3x vacuum: Temperature: 134 °C / 273 °F Time: 5 min Dry: 10 min	<ol style="list-style-type: none"> <li>1. Sterilise the accessories using a suitable procedure: <ul style="list-style-type: none"> <li>• Steam sterilisation / autoclaving</li> </ul> </li> </ol> ☞ Ideally, always use the same procedure. Steriliser: <ul style="list-style-type: none"> <li>• In accordance with EN 285</li> </ul>
<b>Storage</b>	☞ Observe the ambient conditions; see chapter „11 Technical data“ on page 38.

#### 5.4.4 Hoses

☞ Take particular care when reprocessing hard-to-reach areas.

<b>Pre-treating at the site of use</b> Flushing: 5 x / 30s	<ol style="list-style-type: none"> <li>1. Clean the accessories under cold, running water.</li> <li>2. Rinse the hollow spaces and lumina of the accessories thoroughly under running water. <ul style="list-style-type: none"> <li>» No more residue is visible.</li> </ul> </li> </ol>
<b>Collecting and transporting</b>	<ol style="list-style-type: none"> <li>1. Label any damaged accessories.</li> <li>2. Place the accessories in a canister.</li> <li>3. Close the canister.</li> <li>4. Transport the canister to the reprocessing site.</li> </ol>
<b>Pre-cleaning</b> Flushing: 5 x / 30s	☞ Pre-cleaning is only necessary for mechanical cleaning and disinfection. <ol style="list-style-type: none"> <li>1. Clean the accessories evenly under running water.</li> <li>2. Rinse the hollow spaces and lumina of the accessories thoroughly under running water.</li> </ol>
<b>Disassembly</b>	<ol style="list-style-type: none"> <li>1. Not necessary.</li> </ol>
<b>Mechanical cleaning and disinfection</b> Pre-rinse: 1 min Clean: 5 min, 55°C / 131°F Neutralise: 2 min Disinfect: 5 min, 93°C / 199°F Drying: 12 min, 110°C / 230°F	<ol style="list-style-type: none"> <li>1. Empty the rinsing canister.</li> <li>2. Clean and disinfect using a suitable programme: <ul style="list-style-type: none"> <li>• Pre-rinse with cold water</li> <li>• Cleaning with cleaning agent</li> <li>• Neutralise with cold water</li> <li>• Intermediate rinse with softened, cold water</li> <li>• Disinfection with suitable disinfectant and demineralised water</li> <li>• Drying</li> </ul> </li> </ol>

<b>Checking and maintaining</b>	<ol style="list-style-type: none"> <li>1. Check whether reprocessing was successful with a suitable light magnifier.</li> <li>2. If reprocessing was unsuccessful, reprocess the accessories again.</li> <li>3. Dispose of damaged accessories or have them repaired.</li> </ol>
<b>Assembly</b>	Not necessary.
<b>Function check</b>	Not necessary.
<b>Packaging</b>	<ol style="list-style-type: none"> <li>1. Label the accessories.</li> <li>2. Pack the accessories using a packaging system according to DIN EN ISO 11607.</li> </ol>
<b>Sterilisation</b> Pre-fractionated vacuum: 3x Temperature: 134°C / 273°F Time: 5 min Dry: 10 min	<ol style="list-style-type: none"> <li>1. Sterilise the accessories using a suitable procedure: – steam sterilisation / autoclaving Steriliser: in accordance with EN 285.</li> </ol>
<b>Storage</b>	☞ Observe the ambient conditions; see chapter „11 Technical data“ on page 38.

## 5.5 Reprocessing the accessories (ATMOS Twin Record 55 with standard rail)

### 5.5.1 Overview

Accessory	Disposable product	Max. reprocessing cycles	After each use	After each patient	Daily	Weekly	Every 14 days	Monthly	Pre-treatment	Pre-cleaning	Manual cleaning and disinfection	Mechanical cleaning and disinfection	Sterilisation
<b>Secretion canister system</b>													
• Secretion canister <sup>2</sup>		50	x						x	x		x	x
• Canister lid <sup>2</sup>		50	x						x	x		x	x
• Twin hose nozzle <sup>2</sup>		50	x						x	x		x	x
• Hydrophobic bacterial and viral filter <sup>1</sup>	x												
<b>Hoses</b>													
• Suction hose		60	x						x	x		x	x
• Vacuum hose		60	x						x	x		x	x
• Connecting hose		60	x						x	x		x	x

<sup>1</sup> Replace the DDS bacterial and viral filter if it is discoloured, soiled, or if oversuction has occurred; see chapter 4.5.11.

<sup>2</sup> If there are visible defects/ damage, accessories must be replaced.

## 5.5.2 Selecting process chemicals

Follow the manufacturer's instructions for the process chemical.

Cleaning agent (manufacturer)	Active ingredients in 100 g	Type	Secretion canister system	Hoses
<b>Disinfectants - Manual reprocessing</b>				
Gigasept® FF new (Schülke & Mayr)	< 5 % phosphonate, < 5 % anionic surfactant, < 5 % non-ionic surfactants, perfumes, methylisothiazolinones	Liquid concentrate	x	
Cleaning agent (manufacturer)	Active ingredients in 100 g	Type	Secretion canister system	Hoses
<b>Cleaning agents - Mechanical reprocessing</b>				
neodisher® MediClean forte (Dr. Weigert)	<5 % non-ionic and anionic surfactants, enzymes	Liquid concentrate		x

## 5.5.3 Secretion canister system

### Characteristics

The accessories have the following hard-to-reach areas:

- Double hose connector (lumina)
- Secretion canister lid complete (hollow spaces)

Take particular care when reprocessing hard-to-reach areas.

<b>Pre-treating at the site of use</b> Flushing: For 60 s Rinsing: For 60 s	<ol style="list-style-type: none"> <li>1. Empty the rinsing canister</li> <li>2. Clean the accessories under cold, running water.</li> <li>3. Rinse the hollow spaces and lumina of the accessories thoroughly under running water.</li> </ol> » No more residue is visible.
<b>Collecting and transporting</b>	<ol style="list-style-type: none"> <li>1. Label any damaged accessories.</li> <li>2. Place the accessories in a canister.</li> <li>3. Transport the canister to the reprocessing site.</li> </ol>
<b>Disassembly</b>	<ol style="list-style-type: none"> <li>1. See chapter „5.2 Preparing and completing reprocessing“ on page 23.</li> </ol> » Dispose of disposable products

<p><b>Pre-cleaning</b></p> <ul style="list-style-type: none"> <li>• Flushing: 1x / 30s</li> <li>• Rinsing: 60 s</li> </ul> <p><u>Brush: Circular brush</u> Size: 7 mm, Material: Nylon</p> <p><u>Brush: Circular brush</u> Size: 11 mm, Material: Nylon</p> <p><u>Brush: Circular brush</u> Size: 15 mm, Material: Nylon</p> <p><u>Brush: Angular</u> Size: 40 x 10 mm, material: nylon, characteristics: With angled head</p>	<ol style="list-style-type: none"> <li>1. Make the following hollow spaces accessible: <ul style="list-style-type: none"> <li>– Double hose connector</li> <li>– Secretion canister lid</li> </ul> </li> <li>2. Make the following lumina accessible: <ul style="list-style-type: none"> <li>– Double hose connector</li> </ul> </li> <li>3. Clean the accessories evenly with a suitable brush under running water.</li> <li>4. Rinse the hollow spaces and lumina of the accessories thoroughly under running water.</li> </ol>
<p><b>Mechanical cleaning and disinfection</b></p> <p>Pre-rinse: 1 min Clean: 5 min, 50°C / 122°F Neutralise: 2 min Intermediate rinse: 1 min Disinfect: 5 min, 93°C / 199°F Drying: 12 min, 110°C / 230°F</p>	<ol style="list-style-type: none"> <li>1. Secure the accessories on a suitable load carrier.</li> <li>2. Clean and disinfect using a suitable programme: <ul style="list-style-type: none"> <li>• Pre-rinse with cold water</li> <li>• Cleaning with cleaning agent</li> <li>• Neutralise with neutralising agent</li> <li>• Intermediate rinse with softened, cold water</li> <li>• Disinfection with demineralized water</li> <li>• Drying</li> </ul> </li> </ol> <p>Cleaning and disinfection device:      • In accordance with EN ISO 15883-1</p> <p>Programme:                              • Miele Vario TD</p>
<p><b>Checking and maintaining</b></p>	<ol style="list-style-type: none"> <li>1. Check whether reprocessing was successful with a suitable light magnifier. They must be free of particles and organic material.</li> <li>2. If reprocessing was unsuccessful, reprocess the accessories again.</li> <li>3. Dispose of damaged accessories or have them repaired.</li> </ol>
<p><b>Assembly</b></p>	<p>Not necessary.</p>
<p><b>Function check</b></p>	<p>Not necessary.</p>
<p><b>Packaging</b></p>	<ol style="list-style-type: none"> <li>1. Label the accessories.</li> <li>2. Pack the accessories using a packaging system according to DIN EN ISO 11607.</li> </ol>
<p><b>Sterilisation</b></p> <p>Pre-fractionated vacuum: 3x Temperature: 134°C / 273°F Time: 5 min Dry: 10 min</p>	<ol style="list-style-type: none"> <li>1. Sterilise the accessories using a suitable procedure: <ul style="list-style-type: none"> <li>• Steam sterilization / autoclaving</li> </ul> </li> </ol> <p>Steriliser: according to EN 285.</p>
<p><b>Storage</b></p>	<p>☞ Observe the ambient conditions; see chapter „11 Technical data“ on page 38.</p>

## 5.5.4 Hoses

Take particular care when reprocessing hard-to-reach areas.

<b>Pre-treating at the site of use</b>	<ol style="list-style-type: none"> <li>1. Clean the accessories under cold, running water.</li> <li>2. Thoroughly rinse the hollow spaces of the accessories with running water.</li> </ol> <p>» No more residue is visible.</p>
<b>Collecting and transporting</b>	<ol style="list-style-type: none"> <li>1. Label any damaged accessories.</li> <li>2. Place the accessories in a canister.</li> <li>3. Close the canister.</li> <li>4. Transport the canister to the reprocessing site.</li> </ol>
<b>Pre-cleaning</b>	<ol style="list-style-type: none"> <li>1. Clean the accessories evenly under running water.</li> <li>2. Thoroughly rinse the lumina of the accessories with running water.</li> </ol>
<b>Disassembly</b>	Not necessary.
<b>Mechanical cleaning and disinfection</b> Pre-rinse: 1 min Clean: 5 min, 55°C / 131°F Neutralise: 2 min Intermediate rinse: 1 min Disinfect: 5 min, 93°C / 199°F Drying: 12 min, 110°C / 230°F	<ol style="list-style-type: none"> <li>1. Secure the accessories on a suitable load carrier.</li> <li>2. Clean and disinfect using a suitable programme:           <ul style="list-style-type: none"> <li>• Pre-rinse with cold water</li> <li>• Cleaning with cleaning agent</li> <li>• Neutralise with cold water</li> <li>• Intermediate rinse with softened, cold water</li> <li>• Disinfection with demineralized water</li> <li>• Drying</li> </ul> </li> </ol> <p>Cleaning and disinfection device: • In accordance with EN ISO 15883-1</p> <p>Programme: • Miele Vario TD</p> <p>Adapter: • Adapter Miele E366/E446</p>
<b>Checking and maintaining</b>	<ol style="list-style-type: none"> <li>1. Check whether reprocessing was successful with a suitable light magnifier.</li> <li>2. If reprocessing was unsuccessful, reprocess the accessories again.</li> <li>3. Dispose of damaged accessories or have them repaired.</li> </ol>
<b>Assembly</b>	Not necessary.
<b>Function check</b>	Not necessary.
<b>Packaging</b>	<ol style="list-style-type: none"> <li>1. Label the accessories.</li> <li>2. Pack the accessories using a packaging system according to DIN EN ISO 11607.</li> </ol>
<b>Sterilisation</b> Pre-fractionated vacuum: 3x Temperature: 134°C / 273°F Time: 5 min Dry: 10 min	<ol style="list-style-type: none"> <li>1. Sterilise the accessories using a suitable procedure:           <ul style="list-style-type: none"> <li>• Steam sterilisation / autoclaving</li> </ul> </li> </ol> <p>Steriliser: according to EN 285.</p>
<b>Storage</b>	☞ Observe the ambient conditions; see chapter „11 Technical data“ on page 38.

## 6 Maintenance and service

Maintenance, repairs and periodic tests may only be carried out by persons who have the appropriate technical knowledge and who are familiar with the product. The person must possess the test devices and original spare parts required to carry out these measures.

ATMOS recommends: work should be carried out by an authorised ATMOS service partner. This ensures that repairs and tests are carried out professionally, original spare parts are used, and warranty claims are maintained. Maintenance, repairs, and periodic tests must **not** be performed while the product is being used on a patient.

### 6.1 Periodic tests

Perform a repeat test of the electrical safety according to IEC 62353 at least every 12 months.

In this context, ATMOS recommends conducting an inspection in accordance with the manufacturer's specifications.

### 6.2 Function check

- Prior to each use, perform a visual inspection of the device, hoses, secretion canister, and connecting cables.
- Exchange any damaged parts immediately.

### 6.3 Sending in the device

1. Remove all consumables and dispose of them properly.
2. Clean and disinfect the product and accessories according to the operating instructions.
3. Enclose any used accessories with the product.
4. Fill in form QD 434 'Delivery complaint / return shipment' and the corresponding **Decontamination certificate**.
- ☞ This form is enclosed with each delivery and can be found at [www.atmosmed.com](http://www.atmosmed.com).
5. Attach the transport protection.
6. The product must be well padded and packed in suitable packaging.
7. Place form QD 434 'Delivery complaint / return shipment' and the corresponding **Decontamination certificate** in an envelope.
8. Affix the envelope to the outside of the package.
9. Send the product to ATMOS or your dealer.

### 6.4 Reprocessing by the manufacturer

If you pass on the device to a new owner, the device must be reprocessed professionally. The device may only be passed on in a hygienically and technically safe condition. Observe country-specific regulations.

In Germany, only ATMOS or authorised professionals may reprocess the device for distribution.



## 7 Troubleshooting

### 7.1 Troubleshooting

The product has been subjected to thorough quality control in the factory. However, if a fault should occur, you may be able to resolve it yourself.

Error symptom	Possible cause	Remedy
<ul style="list-style-type: none"> <li>• Device does not start</li> </ul>	<ul style="list-style-type: none"> <li>• Power plug fits poorly.</li> <li>• No mains voltage</li> <li>• Defective fuse</li> </ul>	<ul style="list-style-type: none"> <li>• Check the connection at the wall socket and on the device</li> <li>• Check the main fuse</li> <li>• Change the fuse</li> </ul>
<ul style="list-style-type: none"> <li>• Not enough power</li> </ul>	<ul style="list-style-type: none"> <li>• Leakage in the hose or in the secretion canister system</li> </ul>	<ul style="list-style-type: none"> <li>• Check the canister lid, hose adapter, and suction hose for tight fit</li> <li>• Check the canister lid and hoses for tight fit, if necessary replace sealing ring on the canister lid</li> </ul>
<ul style="list-style-type: none"> <li>• No suction capacity</li> </ul>	<ul style="list-style-type: none"> <li>• Bacterial filter is blocked (vacuum gauge indicates vacuum).</li> <li>• Secretion or blood was sucked in and the valve plates of the aggregate are stuck together</li> <li>• The float of the overflow protection seals the double hose connector</li> </ul>	<ul style="list-style-type: none"> <li>• Replace the bacterial filter</li> <li>• Check the fluid level in the secretion canister; if necessary it must be emptied</li> <li>☞ In this case, the device must be sent in for repair</li> <li>• Clean the overflow protection and check the free movement of the float</li> </ul>

## 8 Accessories

Accessories	REF
Foot switch	443.0755.0
Foot controller set for the ATMOS Twin Record 55	443.0770.0
Potential equalisation cable	008.0596.0
Practice package 1.5 l	340.0002.0
Practice package 3 l	340.0003.0
DDS secretion canister, plastic 1.5 l, autoclavable	340.0050.0
DDS secretion canister, plastic 3 l, autoclavable	340.0051.0
DDS secretion canister, plastic 5 l, autoclavable	340.0052.0
DDS secretion canister set 2 x 3 l, autoclavable	444.0901.0
DDS secretion canister set 2 x 5 l, autoclavable	444.0902.0
DDS canister lid, complete set	340.0040.0
DDS canister lid with sealings, autoclavable	340.0053.0
DDS secretion canister handle, grey, autoclavable	340.0055.0
DDS secretion canister handle, blue, autoclavable	340.0326.0
DDS splash protection, silicone, autoclavable	340.0056.0
DDS hose adapter set (Ø 6 mm + Ø 10 mm), autoclavable	340.0057.0
DDS secretion canister hose holder, autoclavable	340.0066.0
DDS adapter for tissue collector	340.0062.0
Storage tray, stainless steel	443.0790.0
Tray, diameter 20 cm	HM57524538
Storage basket, dimensions 170 x 130 x 85 mm	HM57508012
Catheter holder for trolley, dimensions 150 x 100 x 480 mm	HM57508002
Catheter holder, dimensions 90 x 90 x 350 mm	HM57505157
Catheter quiver	HM57525150
Cover for catheter quiver	HM57525151
Secretion canister 1.5 l (PC)	444.0100.0
Secretion canister 3 l (PC)	444.0099.0
Graduated secretion jar 5 l	444.0034.0
Secretion canister lid	444.0650.0
Secretion canister lid incl. standard rail holder	444.0015.0
Nipple set	444.0640.0
Nipple set with overflow electrode	444.0012.0
Serres® outer canister 1 l	312.0465.0
Serres® outer canister 2 l	310.0402.0
Serres® outer canister 3 l	310.0403.0
Standard rail holder for Serres® complete	444.0484.0
Receptal® outer canister 1.5 l	310.0221.0
Receptal® outer canister 2 l	443.0256.0
Receptal® outer canister 3 l	444.0157.0
Receptal® holder complete for standard rail 1 x 2 l	444.0160.0

Accessories	REF
Receptal® holder complete for standard rail 1 x 3 l	444.0170.0
Receptal® holder complete for standard rail (single)	444.0150.0
Receptal® holder complete for standard rail (double)	444.0156.0
Holder for Receptal® canister, with equipment mount	HM57525661
Receptal® package 1 x 2 l for mounting to a standard rail	444.0030.0
Receptal® package 1 x 3 l for mounting to a standard rail	444.0031.0
Receptal® package 2 x 1.5 l for mounting to a standard rail	444.0027.0
Receptal® package 2 x 2 l for mounting to a standard rail	444.0028.0
Receptal® package 2 x 3 l for mounting to a standard rail	444.0029.0
Receptal® adapter for tissue collector	444.0148.0
Medi-Vac® outer canister 1 l	312.0473.0
Standard rail holder Medi-Vac®	444.0451.0
Vacuum shift	HM57522049
Rail clamp for equipment mount, plastic	HM57522540
Rail clamp for equipment mount, metal	HM57522048
Overflow canister 250 ml (without hydrophobic DDS bacterial filter)	444.0646.0
Overflow canister 250 ml (with hydrophobic DDS bacterial filter)	444.0646.1
Hose holder, for attachment to a standard rail	444.0450.0
Hose holder, stainless steel	320.0611.0
Holder for activated charcoal filter, not autoclavable	444.0660.0

## 9 Consumables

Spare parts	REF
Bacterial filter for the ATMOS DDS secretion canister, pack of 10 pcs.	340.0054.0
Suction hose, PVC, disposable, Ø 8 mm, L = 2.10 m, 50 pcs.	006.0059.0
Suction hose, silicone, Ø 6 mm, L = 1.30 m, 1 pc.	000.0013.0
Suction hose, silicone, Ø 6 mm, L = 2 m, 1 pc.	000.0361.0
Suction hose, silicone, Ø 6 mm, 1 m (minimum order 5 m)	006.0009.0
Suction hose, silicone, Ø 10 mm, L = 1.30 m, 1 pc.	318.1012.0
Suction hose, silicone, Ø 10 mm, L = 2 m, 1 pc.	000.0243.0
Suction hose, Ø 10 mm, 1 m (minimum order 5 m)	006.0026.0
Tissue collector 50 ml, disposable	401.0555.0
Hydrophobic bacterial and viral filter, Ø 11 mm	443.0738.0
Hydrophobic bacterial and viral filter, Ø 8 mm	444.0628.0
Smoke evacuation filter	HM57524928
Suction hose, PVC, disposable, Ø 8 mm, L = 2.10 m, 50 pcs.	006.0059.0
Suction hose, silicone, Ø 10 mm, 1 m (minimum order 5 m)	006.0026.0
Serres® disposable suction liner 1 l, without gelling agent, 36 pcs.	312.0466.0
Serres® disposable suction liner 1 l with gelling agent, 32 pcs.	312.0467.0
Serres® disposable suction liner 2 l, without gelling agent, 24 pcs.	310.0410.0
Serres® disposable suction liner 2 l with gelling agent, 22 pcs.	310.0400.0
Serres® disposable suction liner 3 l, without gelling agent, 24 pcs.	310.0411.0
Serres® disposable suction liner 3 l with gelling agent, 20 pcs.	310.0401.0
Hose 287 mm to be connected in series with blue joint	HM57522085
Vacuum silicone hose, to be connected in series 175 mm	HM57522084
Receptal® disposable suction liner 1.5 l, without overflow valve filter, 50 pcs.	310.0222.1
Receptal® disposable suction liner 1.5 l, with overflow valve filter, 50 pcs.	310.0222.2
Receptal® disposable suction liner 2 l, without overflow valve filter, 50 pcs.	443.0257.0
Receptal® disposable suction liner 2 l, with overflow valve filter, 50 pcs.	443.0257.2
Receptal® disposable suction liner 3 l, without overflow valve filter, 50 pcs.	444.0153.0
Receptal® disposable suction liner 3 l, with overflow valve filter, 50 pcs.	444.0154.0
Medi-Vac® disposable suction liner 1 l, 50 pcs.	312.0474.0
Tissue collector 50 ml, disposable	401.0555.0
Tissue collector 300 ml, disposable	340.0061.0
Activated charcoal filter	008.0758.0
Hose connector for reducing from Ø 10 mm to Ø 6 mm	000.0239.0
Sealing for canister lid	055.0070.0

# 10 Disposal

## Packaging

1. Please recycle the product packaging.

## Secretion and blood

1. Please dispose of secretion, blood and contaminated parts in line with country-specific regulations.

In the Federal Republic of Germany, the requirements of the 'Implementation Aid for Disposal of Waste from Healthcare Institutions' apply, a statement issued by the Federal / State Working Group on Waste.

## Secretion canister system

Disposable products may not be reprocessed and may not be reused! Please discard disposable products properly.

The following notes only apply to reusable products.

1. Clean and disinfect the reusable products of the secretion canister system.
2. Recycle the disinfected reusable products.

## ATMOS Twin Record 55

Do not dispose of the product together with household waste.

The product does not contain any hazardous materials.

1. Clean and disinfect the product.
2. In Germany: send the product back to ATMOS or your specialist dealer. They will dispose of the product properly.
3. For other countries: Dispose of the product properly and in accordance with country-specific laws and regulations.

In Germany, the product is excluded from the Electrical and Electronic Equipment Act (ElektroG) in accordance with the National Register for waste electric equipment because it may be contaminated. Do not dispose of the product in electronic waste.



In principle, the housing is fully recyclable. However, please observe country-specific laws and regulations.



## 11 Technical data

### 11.1 ATMOS Twin Record 55 DDS

Voltage	230 V~ ± 10%; 50/60 Hz
Current consumption	for each pump approx. 0.45 A (230 V~)
Power consumption	Approx. 200 W
Fuses	2x T 1.25 A/H (250 V~)
Temperature protection switch in the pump	150°C
Secretion canister	340.0050.0 DDS secretion canister, plastic 1.5 l, autoclavable 340.0051.0 DDS secretion canister, plastic 3 l, autoclavable 340.0052.0 DDS secretion canister, plastic 5 l, autoclavable 444.0901.0 DDS canister set 2 x 3 l, autoclavable 444.0902.0 DDS canister set 2 x 5 l, autoclavable
Suction hose	Ø 6 mm, L = 2 m Ø 10 mm, L = 2 m
Suction capacity (in the pump)	Each pump 55 l/min ± 3 l/min
Max. vacuum at MSL	Each pump - 98 kPa (- 980 mbar or -735 mmHg) * or 97% of the daily air pressure * Data may differ depending on elevation above sea level, prevalent air pressure and air temperature.
Vacuum display	-1...0 bar (± 2.5 % of the final value)
Vacuum setting	Infinitely variable vacuum regulator
Operating time	>8 h continuous operation (depending on ambient conditions)
Protective earth conductor resistance	max. 0.1
Earth leakage current	max. 5 mA
Housing leakage current	max. 0.1 mA
Patient leakage current	---
Noise level	Free flow: 52.4 dB(A) @ 1m Final vacuum: 43.9 dB (A) @ 1m
Ambient conditions	
Transport/storage:	
Temperature	-30...+50°C
Humidity without condensation	5...90 %
Pressure	700...1060 hPa

Ambient conditions for operation	+10...+32°C
Temperature	20...80 %
Humidity without condensation	700...1060 hPa
Pressure	
Max. operational altitude	3000 m (above MSL)
Contamination level	Class 2
Overvoltage category	II
Dimensions H x W x D	910 x 540 x 440 mm (without secretion canister)
Weight	30.4 kg (without secretion canister)
Periodic tests:	Repeat test of electrical safety every 12 months. Recommended: inspection according to manufacturer's specifications.
Protection class (EN 60601-1)	I
Degree of protection	 Applied part type BF
Type of protection	IPX1
Classification as per Annex IX to Directive 93/42/EEC	Class IIa according to Rule 11
Risk class (according to MDR)	Class IIa according to Rule 12
CE marking	 0124
GMDN code	63642 (Surgical Suction Pump)
UMDNS code	10-217 (Aspirators, surgical)
MD/MDS code	MD 1104 (Active surgical devices)/ MDA 0312 (Other active non-implantable surgical device)
Basic UDI device identifier	42503651SurgicalRecord5JV
ID No. (REF)	443.0950.0 ATMOS Twin Record 55 DDS



\* 1 bar  $\cong$  750,06 mm Hg  $\cong$  1000 hPa / dependent on daily air pressure

## 11.2 ATMOS Twin Record 55 with standard rail

Voltage	230 V~ $\pm$ 10%; 50/60 Hz
Current consumption	for each pump approx. 0.45 A (230 V~)
Power consumption	ca. 200 W
Fuses	2x T 1.25 A/H (250 V~)
Thermal shutdown in the pump	150°C

Secretion canister	444.0034.0 Graduated secretion jar 5 l 444.0100.0 Secretion canister 1.5 l (PC) 444.0099.0 Secretion canister 3 l (PC) HM57525656 Secretion canister 4 l PSU with equipment mount HM57525658 Secretion canister 4 l PC with equipment mount 310.0402 x Serres®-outer canister 2 l 310.0403.0 Serres®-outer canister 3 l 443.0256.0 Receptal® outer canister 2 l 444.0157.0 Receptal® outer canister 3 l
Suction hose	Ø 6 mm, L = 2 m Ø 10 mm, L = 2 m
Suction capacity (in the pump)	Each pump 55 l/min ± 3 l/min
Max. vacuum at MSL	Each pump - 98 kPa (- 980 mbar or -735 mmHg) * or 97% of the daily air pressure * Data may differ depending on elevation above sea level, prevalent air pressure and air temperature.
Vacuum display	-1...0 bar (± 2,5 % of the final value)
Vacuum setting	Infinitely variable vacuum regulator
Operating time	>8 h continuous operation (depending on ambient conditions)
Protective earth conductor resistance	max. 0.1
Earth leakage current	max. 5 mA
Housing leakage current	max. 0.1 mA
Patient leakage current	---
Noise level	Free flow: 48.6 dB(A) @ 1m Final vacuum: 44.8 dB (A) @ 1m
Ambient conditions for transport/storage	
Temperature	-30...+50°C
Humidity without condensation	5...90 %
Pressure	700...1060 hPa
Ambient conditions for operation	
Temperature	+10...+32°C
Humidity without condensation	20...80 %
Pressure	700...1060 hPa
Max. operational altitude	3000 m (ABOVE MSL)
Contamination level	Class 2
Overvoltage category	II



Dimensions H x W x D	910 x 540 x 440 mm (without secretion canister)
Weight	30 kg (without secretion canister)
Periodic tests:	Repeat test of electrical safety every 12 months. Recommended: inspection according to manufacturer's specifications.
Protection class (EN 60601-1)	I
Degree of protection	 Applied part type BF
Type of protection	IPX1
Classification as per Annex IX to Directive 93/42/EEC	Class IIa according to Rule 11
Risk class (according to MDR)	Class IIa according to Rule 12
CE marking	 0124
GMDN CODE	63642 (Surgical Suction Pump)
UMDNS CODE	10-217 (Aspirators, surgical)
MD/MDS CODE	MD 1104 (Active surgical devices)/ MDA 0312 (Other active non-implantable surgical device)
BASIC UDI DEVICE IDENTIFIER	42503651SurgicalRecord5JV
ID No. (REF)	443.0960.0 ATMOS Twin Record 55 with standard rail

## 12 Notes on EMC

- Medical electrical devices are subject to special precautions with regard to EMC and must be installed according to the following EMC notes.

### Guidance and manufacturer's declaration – ambient conditions

The ATMOS Twin Record 55 is suitable for use in the following environments:

- In professional healthcare facilities such as medical practices, clinics, first-aid facilities and operating theatres/rooms.  
It is not suitable for use in the vicinity of HF surgical devices and in settings outside of an HF-shielded room of a magnetic resonance imaging system.
- Special environments such as factory or military facilities and medical areas near HF surgical devices, short-wave therapy equipment or within an HF-shielded room of a magnetic resonance imaging system.

The customer or user of the ATMOS Twin Record 55 must ensure that it is used in such an environment.

### Guidance and manufacturer's declaration – key features

- Please note the technical data in these operating instructions. The essential features are fully usable even in the presence of electromagnetic disturbances.

### Guidance and manufacturer's declaration – for accessories, transducers, and cables

The ATMOS Twin Record 55 has the following electrical components:

Type	REF	Max. cable length
Power cable	008.0629.0	5 m

### Guidance and manufacturer's declaration – warnings

#### **⚠ WARNING**

The use of accessories, transducers, and cables other than those specified or provided by the manufacturer may result in increased electromagnetic emissions or decreased immunity to electromagnetic interference and result in improper operation.

#### **⚠ WARNING**

Portable RF communications equipment (for example, radios, antenna cables) should be used no closer than 30 cm\* to the manufacturer's designated parts or cables of the ATMOS Twin Record 55 . Failure to heed this warning may result in a reduction in the device's performance.

- \*The distance may be reduced at higher immunity test levels.

#### **⚠ WARNING**

Avoid placing the device on top of or next to another device. This could result in faulty operation. If such placement cannot be avoided, the proper functioning of the device must be monitored regularly. If possible, please switch off any nearby devices that are not in use.

## 13 Notes



**MedizinTechnik**

🏠 ATMOS MedizinTechnik GmbH & Co. KG  
Ludwig-Kegel-Str. 16  
79853 Lenzkirch / Germany  
Phone: +49 7653 689-0  
atmos@atmosmed.de

[www.atmosmed.com](http://www.atmosmed.com)