

OPERATING INSTRUCTIONS

MEDAP
LS FLOW FLOWMETER
INSTALLATION VERSION

MEDAP 



Subject to technical modification!

Illustrations and technical specifications may vary slightly from those in these Operating Instructions as a result of ongoing product development.

V06 2018-02





Table of contents

1	Introduction	5
1.1	Foreword	5
1.2	How to use these operating instructions	5
1.2.1	Abbreviations	5
1.2.2	Symbols	5
1.2.2.1	Cross-references	5
1.2.2.2	Actions and responses	5
1.2.3	Definitions	6
1.2.3.1	Design of safety notes	6
1.2.3.2	Design of other notes	6
1.2.4	Symbols used	6
1.3	Disposal.....	7
1.3.1	ATMOS products.....	7
1.3.2	Packing	8
1.4	Overview	8
1.5	Basic requirements.....	8
1.5.1	Use in accordance with the intended purpose	8
1.5.2	Applicable standards.....	9
1.5.3	Intended purpose	9
1.5.3.1	Possible applications	10
1.5.4	Interface description.....	10
1.5.4.1	Flowmeter outlet	10
1.5.4.2	Connection tube	10
1.5.4.3	Tube adapter for Air and O2	11
2	Safety notes	12
2.1	General safety notes	12
2.2	Product safety notes.....	12
3	Initial operation.....	14
3.1	Equipment inspection	14
3.2	Mounting accessories.....	14
3.2.1	General	14
3.2.2	Connection of MEDAP bubble humidifier (REF 5750 7525)	14
3.2.3	Connection of bubble humidifier (REF 5752 5315).....	15
3.2.4	Connection of disposable humidifiers from other manufacturers	15
4	Operation	16
4.1	Functional test.....	16
4.2	Setting the flow for treatment	16
5	Taking the unit out of operation.....	18



- 6 Cleaning and disinfection..... 19**
 - 6.1 General..... 19
 - 6.2 Special safety notes 20
 - 6.3 Cleaning 20
 - 6.3.1 General 20
 - 6.3.2 Cleaning procedure..... 20
 - 6.4 Disinfection..... 21
 - 6.4.1 General 21
 - 6.4.2 Suitable disinfectants 21
 - 6.4.3 Disinfection procedure 22
- 7 Maintenance..... 23**
 - 7.1 General..... 23
 - 7.2 Period tests 23
 - 7.3 Malfunctions and troubleshooting..... 23
 - 7.4 Repairs 24
 - 7.5 Service hotline:..... 24
 - 7.6 Type plate position 24
 - 7.7 Sending in the device 24
- 8 Technical specifications 25**
 - 8.1 General..... 25
 - 8.2 Technical specifications 25
 - 8.3 Ambient conditions 25
 - 8.4 Dimensions and weight 25
- 9 Approved accessories 26**
 - 9.1 Accessories 26

1 Introduction

1.1 Foreword

Your facility has selected the leading-edge medical technology made by ATMOS. We sincerely appreciate the trust you have placed in us.

1.2 How to use these operating instructions

These operating instructions are provided to familiarise you with the features of this ATMOS product. They are subdivided into several chapters.

Please note:

- Please read these operating instructions carefully and completely before using the product for the first time.
- Always proceed in accordance with the information contained herein.
- Store these operating instructions in a location near the product.

1.2.1 Abbreviations

EN	European standard
EEC	European Economic Community
PD	Punched disc

1.2.2 Symbols

1.2.2.1 Cross-references

References to other pages in these operating instructions are identified with a double arrow symbol „»“.

1.2.2.2 Actions and responses

The „☒“ symbol identifies an action taken by the user while the „✓“ symbol identifies the reaction that this will induce in the system.



Example:

☒ Turn on the light switch.

✓ Lamp lights up.

1.2.3 Definitions



1.2.3.1 Design of safety notes

Pictogram	Descriptor	Text
	DANGER! Indicates a direct and immediate risk to persons, which may be fatal or result in most serious injury.	The text for the safety note describes the type of risk and how to avert it.
	WARNING! Indicates a potential risk to persons or property which may result in health hazard or grave property damage.	
	CAUTION! Indicates a potential risk to property which may result in property damage.	

Tab. 1: Design of safety notes

1.2.3.2 Design of other notes



Notes not referring to personal injury or property damage are used as follows:









Pictogram	Descriptor	Reference to
	NOTE	Supplementary assistance or further useful information.
	ENVIRONMENT	Information regarding proper disposal.

Tab. 2: Design of other notes

1.2.4 Symbols used

Symbols are attached to products, type plates and packaging.

Symbols	Identification
	Labelling for products which were developed and are marketed in compliance with the 93/42/EEC Medical Products Directive. Class Is, Im, IIa, IIb and III products are also marked with the identifying number for the notified body.
	Labelling in compliance with the ISO 15223-1 standard. Symbol for "Serial number".
	Labelling in compliance with the IEC 60601-1 standard. Symbol for "Follow Operating Instructions".

Symbols	Identification
	Packaging label. Symbol for "Keep dry".
	Packaging label. Symbol for "Fragile! Handle with care".
	Packaging label. Symbol for "Top".
	Labelling in compliance with the ISO 15223-1 standard. Symbol for "Temperature limitations".
	Labelling in compliance with the ISO 15223-1 standard. Symbol for "Relative humidity".
	Labelling in compliance with the ISO 15223-1 standard. Symbol for "Atmospheric pressure".
	Meaning of type plate. Symbol for "oil- and fat-free".
	Labelling in compliance with the ISO 15223-1 standard. Symbol for "Product number".
	Labelling in compliance with the ISO 15223-1 standard. Symbol for "Name and address of the manufacturer as well as date of manufacture".

Tab. 3: Symbols

1.3

Disposal



WARNING!

Infection hazard!

The product or some of its components may be contaminated after use.

Clean and disinfect the product before disposal.

1.3.1

ATMOS products

ATMOS will take back used products or those which are no longer in service.

Please contact your ATMOS representative for more detailed information.

1.3.2 Packing

The packing is made of materials compatible with the environment. ATMOS will dispose of the packing materials upon request.

1.4 Overview

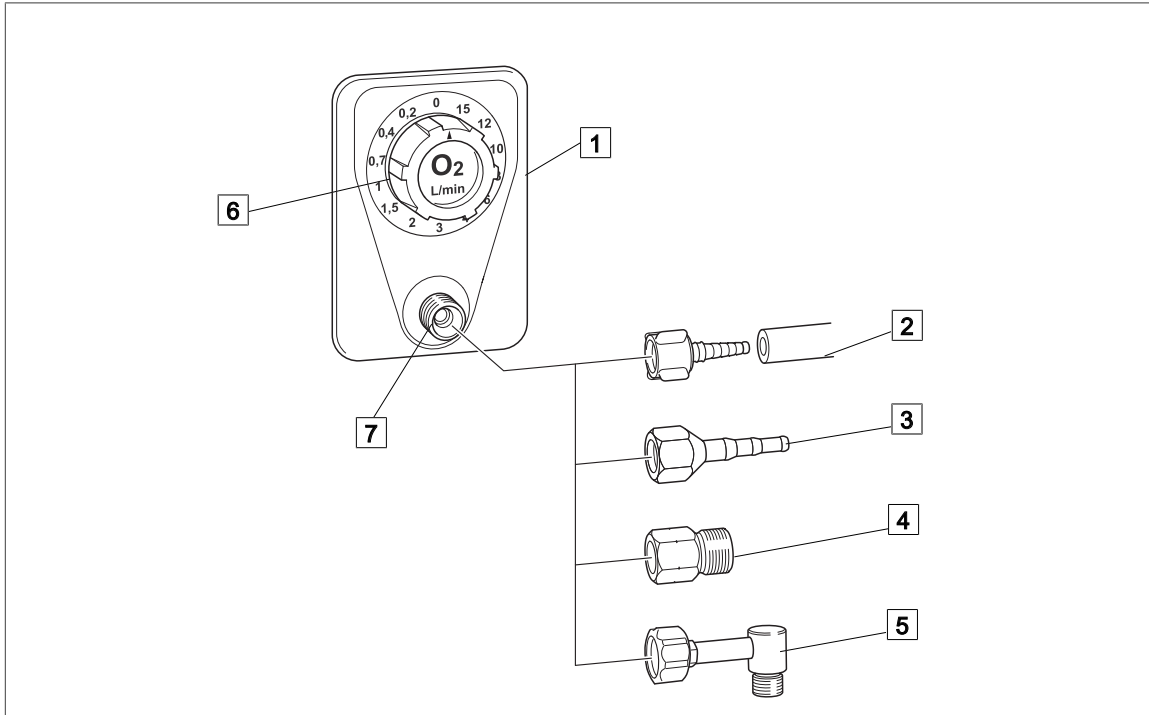

Fig. 1: Overview

- | | |
|---|----------------------------------|
| 1 LS FLOW flowmeter installation version | 5 Angled adapter (REF 5752 5606) |
| 2 Tube adapter, plastic, 4 mm, 6 mm, 8 mm (REF 5752 5316) | 6 Rotation regulator |
| 3 Tube adapter 4 mm, 6 mm, 8 mm (REF 5752 2746) | 7 Flowmeter outlet (UNF 9/16") |
| 4 Adapter for MEDAP humidifier (REF 5752 2745) | |

1.5 Basic requirements

1.5.1 Use in accordance with the intended purpose

Product

As per appendix IX of the Medical Products Directive 93/42/EU this product belongs to class IIa.

In accordance with this directive the product may only be used by persons who have been instructed how to use this product by an authorised person.

This product is to be used exclusively for human medicine.

When employed in a commercial or business use, this product shall be entered in the inventory.

Accessories

Accessories or combinations of accessories may be utilised only as and when indicated in these operating instructions.

Other accessories, combinations of accessories and consumable items may be used only if they have a valid certification, are intended expressly for the particular use and will not adversely affect performance, the prescribed ambient conditions or safety requirements.

1.5.2 Applicable standards

The product satisfies the basic requirements set forth in Annex I to the 93/42/EU Directive drafted by the Medical Products Council (Medical Products Directive) as well as the applicable national (German) codes and the Medical Products Act in Germany. This is certified by compliance with harmonised standards such as IEC 60601-1 and related standards and the respective special sections.

1.5.3 Intended purpose

Name:	LS FLOW installation version
Main function:	Designed for measuring the flow and determining the precise dosage for the supply of oxygen and compressed air. In conjunction with a hand-held nebuliser the LS FLOW is used to provide metered administration of medication aerosols.
Medical indications / application:	Inhalation and insufflation of oxygen within the scope of oxygen enrichment via an inhalation mask or a nose latch for patients breathing by themselves Together with a hand-held nebuliser administration of water soluble drugs via an inhalation mask
Specification of the main function:	Supply of oxygen or compressed air. The LS FLOW installation variant is permanently installed into a pendant or a wall channel instead of a terminal unit oxygen / compressed air. For humidification of the oxygen from the central gas supply system a humidifier may additionally be connected. Supply of oxygen to the patient takes place via connection tubes and an inhalation mask or a nose latch. The administration of medication aerosols via compressed air takes place via connection tubes to a hand-held nebuliser. The patient presses the inhalation mask of the hand-held nebuliser onto mouth and nose.
User profile:	Doctor, medically trained staff
Patient groups:	Patients of all ages
Application organ:	Lung
Application time:	For continuous operation; in practice short-term use on the patient (< 30 days)
Application site:	The application site is the clinical environment and doctor's practices which have a central oxygen / compressed air system. The application of the product may only be performed by medically trained and introduced staff.

Contraindications:	The LS FLOW may not be used for the following purposes: <ul style="list-style-type: none"> • Outside the medical sector • In MR areas • In the home care sector • Being operated directly by the patient • For exclusive respiration • When applying oxygen in its function as a medication, it is absolutely necessary to measure the flow rate.
The product is:	Not active
Sterility:	No sterile product
Single-use product / reprocessing:	The device and parts of the accessories are reusable. For information on reprocessing, cleaning and disinfection please see the operating instructions.

1.5.3.1 Possible applications

The following usage options are made possible by connecting products or accessories which are contained in the list of accessories or which satisfy the specifications of the interface description.

- A metal tube adapter (REF 5752 2746) or plastic (REF 5752 5316) can be used to connect suitable connection tubes with inner diameters of 4 mm, 6 mm and 8 mm to the flowmeter.
- With the bubble humidifier (REF 5752 5315) for humidifying oxygen. The bubble humidifier is intended for inhalation. The bubble humidifier is connected via the angled adapter (REF 5752 5606).
- With the MEDAP bubble humidifier (REF 5750 7525) for humidifying oxygen. The bubble humidifier is intended for inhalation. The bubble humidifier is connected via the angled connection (REF 5752 5606) and the adapter for the MEDAP-humidifier (REF 5752 2745).
- Sterile water systems / disposable humidifiers (UNF 9/16") can be connected via the angled adapter (REF 5752 5606).

1.5.4 Interface description

All devices and accessories which are combined with the tapping unit must be listed in the accessories list or meet the specifications of the interface description. The configuration of the overall system as well as the functional testing are subject to the overall responsibility of the medical staff. Functionality and suitability of the connected accessory for each intended application must be checked by the operator before every use. This includes the functionality of the connector components, its air tightness and suitability regarding material properties, working pressure and flow rate.

1.5.4.1 Flowmeter outlet

The internal thread on the accessory must match the external thread on the flowmeter (UNF 9/16" 18 gear). Ensure that the connection between the flowmeter and the accessory is leak-free.

1.5.4.2 Connection tube

The connection tube with the inner diameter of 4, 6 or 8 mm is connected with the tube adapter.

The connection tube may not collapse or must be pressure-resistant and must comply with the hygiene standard of the hospital. The inside diameter of the connection tube must match the outside diameter of the tube adapter.

1.5.4.3 Tube adapter for Air and O₂

The tube adapter is used to connect the tapping unit and the connection tube. The inner thread of the tube adapter must match the outer thread of the tube connector of the flowmeter output (UNF 9/16").

2 Safety notes

2.1 General safety notes

**DANGER!**

Incorrect use can result in fatalities!

Instructions for using components made by other manufacturers are not part of these operating instructions.

Ensure that the manufacturer's instructions are followed.

**DANGER!**

Observe hygiene guidelines!

Contaminated components may be hazardous to the patient's health.

Prepare the product according to the hygiene guidelines before using it for the first time. Clean and disinfect the product.

**DANGER!**

Fire/explosion hazard!

Air, oxygen and oxygen compounds react explosively with oils, greases and lubricants. Fire and explosion hazard due to compressed gases.

Always keep the product free of oils, greases and lubricants. Only use sliding means (lubricants) approved by ATMOS for this product.

**DANGER!**

Risk of fire!

Escaping oxygen increases the risk of fire.

Never smoke near equipment which carries oxygen and avoid using open fires or glowing objects. Check tight fitting and firm seat of the connector when mounting accessories.

**DANGER!**

Defective product!

Using incorrect spare parts and accessories can cause injuries or equipment failure.

Only use original accessories or spare parts.

**WARNING!**

Risk of injury!

Hazard resulting from incorrect handling.

Follow the operating instructions for all accessories.

2.2

Product safety notes

**WARNING!**

Impacts!

Impacts may cause damage to sensitive, precision mechanical components.

Do not expose the product to impacts.

**WARNING!**

Non-permissible load!

If the permissible load is exceeded, leakages may occur.

The overall weight of the products and accessories may not exceed 2 kg.

**WARNING!**

Property damage!

Product may not be dismantled or disassembled.

**CAUTION!**

Malfunction!

Ensure that the connection between the product and the accessory is leak-free.

**CAUTION!**

Property damage

Exposure to UV rays can cause material fatigue. The stability would no longer be ensured.

Do not expose the product to strong UV light.

**CAUTION!**

Observe ambient conditions

The precision, operation, mechanical stability and tightness of the product cannot be guaranteed if the maximum upper and lower ambient temperatures are exceeded.

3 Initial operation

3.1 Equipment inspection



DANGER!

Product testing!

Only product parts which are in perfect condition can ensure proper functioning of the product. The product parts will thus have to be carefully inspected before mounting.

- Check whether all tubes are undamaged.
- Check whether the unit has been properly cleaned and that there are no residues or soiling.
- Do not use damaged components.

3.2 Mounting accessories

3.2.1 General



WARNING!

Tensile forces!

The connected accessories must not exert any mechanical forces which could adversely affect the secure seating of the product.

3.2.2 Connection of MEDAP bubble humidifier (REF 5750 7525)

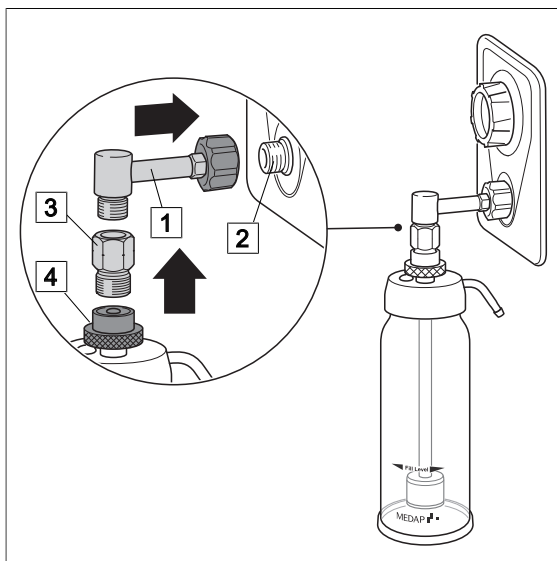

Fig. 2: Connection of bubble humidifier

Connecting the bubble humidifier

- Ensure that the cap nut of the humidifier contains a flat seal in the adapter and angled adapter.
- Fill the humidifier bottle up to the marking "Filling level" with distilled water and screw the bubble humidifier cap into place.
- Screw the angled adapter (1) to the flowmeter output (2) and tighten finger-tight until stop.
- Screw the adapter (3) to the angled adapter (1) and tighten finger-tight until stop.
- Screw the bubble humidifier (4) to the adapter (3) and tighten finger-tight until stop.
- Pay attention that no tensile forces affect the bubble humidifier.

3.2.3 Connection of bubble humidifier (REF 5752 5315)

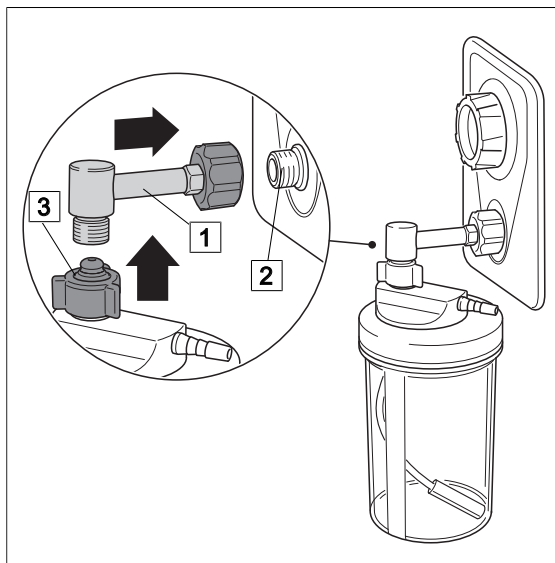

Fig. 3: Connection of bubble humidifier

Connecting the bubble humidifier

- ☒ Ensure that the cap nut of the humidifier and the angled adapter contain a flat seal.
- ☒ Fill the humidifier bottle up to the marking "Filling level" with distilled water and screw the bubble humidifier cap into place.
- ☒ Screw the angled adapter (1) to the flowmeter output and tighten finger-tight until stop.
- ☒ Screw the bubble humidifier cap (3) to the angled adapter (1) and tighten finger-tight until stop.
- ☒ Pay attention that no tensile forces affect the bubble humidifier.

3.2.4 Connection of disposable humidifiers from other manufacturers

Disposable humidifiers complying with the interface description may be connected to the flowmeter outlet.

- ☒ Screw the disposable humidifier directly to the flowmeter output (2) and tighten finger-tight until stop.

4 Operation

4.1 Functional test

**DANGER!**

Functional check!

The product is used in the treatment of patients. Any restriction in the unit's performance can result in serious complications in treatment.

Perform a complete functional check every time before using the unit.

Perform a complete functional check of the tapping unit prior to use.

- The tube connectors are firmly seated and tightly sealed and no mechanical forces are acting on the tubes.
- The plastic and rubber product parts are in perfect condition and show no signs of ageing.
- The accessories are correctly connected.
- The product is leak-free.
- It is possible to adjust the flow rate from zero to the maximum flow.
- The product is in a perfect hygienic condition.

4.2 Setting the flow for treatment

**WARNING!**

Compressed gas setting!

The regulating mechanism is sensitive. Make the compressed gas settings very carefully!

**NOTE**

When applying oxygen in its function as a medication, it is absolutely necessary to measure the flow rate, as per the monograph in the European Pharmaceuticals Reference.

**NOTE**

The flow rate can be set to the following 14 values: 0; 0,2; 0,4; 0,7; 1; 1,5; 2; 3; 4; 6; 8; 10; 12; 15.

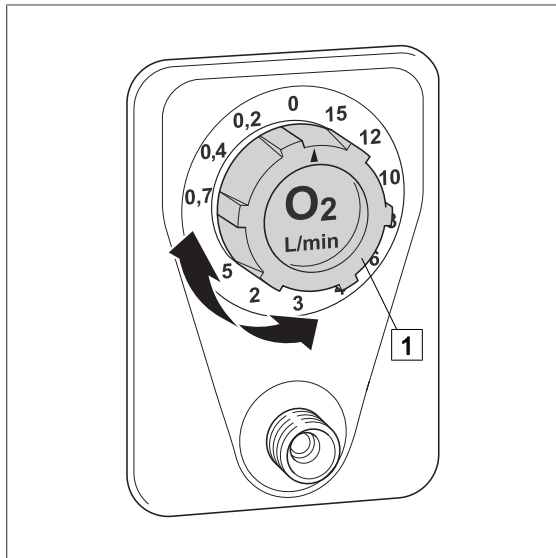

Fig. 4: Setting the flow

Use the rotation regulator to set the flow rate to the required value for the treatment.

Increasing the flow rate

- Turn the rotation regulator (1) anti-clockwise.
 - ✓ The flow rate is increased.

Reducing the flow rate

- Turn the rotation regulator (1) clockwise.
 - ✓ The flow rate is decreased.

5 **Taking the unit out of operation**

- After having completed the treatment, close the rotation regulator by turning it clockwise as far as it will go.
- Check to ensure it is closed.
 - ✓ Arrow on the rotation regulator displays zero.

6 Cleaning and disinfection

6.1 General

The product must be wipe or spray disinfected after every use.

**DANGER!**

Risk due to incorrect use of detergents and disinfectants!

It is strictly advised to observe the manufacturer instructions regarding how to use the detergents and disinfectants as well as the valid hospital hygiene rules.

**DANGER!**

Health hazard!

Disinfectant and cleaning agents may not enter the product.

**DANGER!**

Infection hazard!

Product may be contaminated.

Always wear gloves for cleaning and disinfection.

**DANGER!**

Infection hazard!

Particles of grime may become encapsulated and lead to the product not reaching the desired germ-reduction after disinfection.

Before disinfection, the product must be cleaned thoroughly of contamination and encapsulated particles of grime.

**CAUTION!**

Improper cleaning and disinfection can cause property damage!

Do **not** use the following products for cleaning and disinfection:

- Products containing alcohol (e. g. hand disinfectants)
- Halogenides (e. g. fluorites, chlorides, bromides, iodides)
- Dehalogenating compounds (e. g. fluorine, chlorine, bromine, iodine)
- Products that may scratch the surface (e. g. scouring agents, wire brushes, wire wool)
- Standard commercial solvents (e. g. benzene, thinner)
- Water containing iron particles
- Cleaning sponges containing iron
- Products containing hydrochloric acid

Use a soft, lint free cloth or a soft nylon brush to clean the product.

**CAUTION!**

Improper cleaning and disinfection can cause property damage!

Use only as much detergent and disinfectant as required.

**CAUTION!**

Improper cleaning and disinfection can cause property damage!

Perform visual and functional inspections after each cleaning and disinfection process.

6.2 Special safety notes**DANGER!**

Material damage!

Various components in the product are made of plastic materials. Solvents and some disinfectants and some cleaning agents can soften plastic or cause tension fissures.

Never use detergents that contain alcohol. Observe cleaning and disinfection standards.

6.3 Cleaning**6.3.1 General****NOTE**

Use only all-purpose cleaners which are slightly alkaline (soap solution) and contain tensides and phosphates as the active cleaning agents.

In the event of heavily contaminated surfaces, use concentrated multi-purpose detergent.

**CAUTION!**

Improper cleaning can cause property damage!

Residues of physiological saline solutions (e. g. sodium chloride) can attack the surfaces of the product.

Remove residues of physiological saline solutions with a cloth dipped in clean water. Then dry the product with a dry, lint free cloth.

**CAUTION!**

Improper cleaning can cause property damage!

Do not spray cleaning agent directly into the joints or gaps and never use a high-pressure cleaning unit!

6.3.2 Cleaning procedure

- Use the correct dose of multi-purpose detergent with water for the degree of surface contamination and in accordance with the instructions of the detergent manufacturer.
- Thoroughly wipe off the product with a soft cloth slightly wetted in a multi-purpose detergent solution.
- Ensure that the product is free from contamination and encapsulated particles of grime
- Thoroughly wipe off the product with a soft cloth dipped in clean water.
- Ensure that the product is free of detergent residues.
- Dry product with a dry, absorbent and lint free cloth.
 - ✓ This will help to reduce pathogen growth on the product's surface.
- Wipe or spray disinfect the product after every cleaning.

6.4 Disinfection

6.4.1 General



NOTE

In the event of product surfaces that are very dirty, carry out an additional cleaning procedure before disinfecting.



WARNING!

Property damage!

Disinfectants that contain volatile aromatic hydrocarbons, ammoniac, amine, ester, halogenated hydrocarbons and / or ketone, may attack plastics made of polycarbonate.

Do not use disinfectants with these ingredients.



CAUTION!

Material damage due to excessive exposure times!

Exceeding the specified exposure time of the disinfectant may damage the surfaces.

Observe the specified exposure time of the disinfectant manufacturer.



NOTE

Heavily diluted disinfectants may be used for disinfection.

6.4.2 Suitable disinfectants

Only surface disinfectants based on the following combinations of active ingredients may be used for disinfection:

- Aldehydes
- Quarternary compounds
- Guanidine derivatives

Ingredient group	Active ingredients
Aldehydes	2-ethyl-1-hexanal, formaldehyde, glutardialdehyde, glyoxal, o-phthaldialdehyde, succinaldehyde
Quarternary compounds	Alkyl-didecyl-polyoxethyl ammonium propionate, alkyl-dimethyl-alkylbenzyl ammonium chloride, alkyl-dimethyl-ethyl ammonium chloride, alkyl-dimethyl-ethylbenzyl ammonium chloride, benzalkonium propionate, benzalkonium chloride (alkyl-dimethyl-benzyl ammonium chloride, coco-dimethyl-benzyl ammonium chloride, lauryl-dimethylbenzyl ammonium chloride, myristyl-dimethyl-benzyl ammonium chloride), benzethonium chloride, benzyl-dihydroxyethyl-coco-alkyl ammonium chloride, dialkyl-dimethyl ammonium chloride (didecyldimethyl ammonium chloride), didecyl-methyl-oxyethyl ammonium propionate, mecetronium-ethyl sulfate, methyl-benzethonium chloride, n-octyl-dimethyl-benzyl ammonium chloride

Ingredient group	Active ingredients
Guanidine derivatives	Alkyl-biguanide, chlorhexidine-digluconate, cocospropylene-diamine guanidinium diacetate, oligomeric biguanide, polyhexamethylene biguanide hydrochloride (oligo-diimino imido-carbonyl imino-hexamethylene, polyhexanide)

Tab. 4: Active ingredients of disinfectants

6.4.3 Disinfection procedure

- Wipe or spray disinfect the product in accordance with the instructions of the disinfectant manufacturer.
- Ensure that the product is free of disinfectant residue.
- Perform visual and functional inspections.

7 Maintenance

7.1 General

Maintenance, repairs and period tests may only be carried out by persons who have the appropriate technical knowledge and are familiar with the product. To carry out these measures the person must have the necessary test devices and original spare parts.

ATMOS recommends: Work should be carried out by an authorized ATMOS service partner. This ensures that repairs and testing are carried out professionally, original spare parts are used and warranty claims remain unaffected.



DANGER!

Health hazard!

The product is used in the treatment of patients. The product or some of its components may be contaminated.

Clean and disinfect the product before maintenance and repair.

Repair work may be performed by personnel authorized by ATMOS.

7.2 Period tests

At least every 5 years a test must be performed.

7.3 Malfunctions and troubleshooting

Defect	Source of malfunction	Troubleshooting
No flow	Flow rate is set to the value "0"	Set the flow rate to the desired value
	Product defective	Have the equipment repaired by a service technician authorised by ATMOS
Flow does not stop	Flow rate is not set to the value "0"	Set the flow rate to the value "0"
	Product defective	Have the equipment repaired by a service technician authorised by ATMOS
The value of 15 l/min cannot be achieved even if the flow rate is adjusted to the max. value.	The pressure from the central gas supply system is not high enough	Check the pressure supplied by the central gas supply installation
	Sintered filter is clogged	Have the equipment repaired by a service technician authorised by ATMOS
Full loss of pressure at the flowmeter	Seal is missing or defective	Have the equipment repaired by a service technician authorised by ATMOS
	There is a leak in the housing	
	Accessories are not tightened	Check seating of accessories

Tab. 5: Troubleshooting

7.4 Repairs

The following may require repairs from the manufacturer or an authorized service partner:

- Liquid has penetrated the device.
- The performance has significantly decreased.
- Inexplicable notifications appear.
- Abnormal noises occur.
- Functional faults cannot be rectified according to the measures in chapter Malfunctions and troubleshooting [▶▶ page 23].

If defects are detected the product may not be used any longer.

Make a note of the deficiencies and the REF number on the data plate and inform the responsible ATMOS Service.

Observe the information in chapter Sending in the device [▶▶ page 24].

7.5 Service hotline:

+49 7653 689-0

7.6 Type plate position

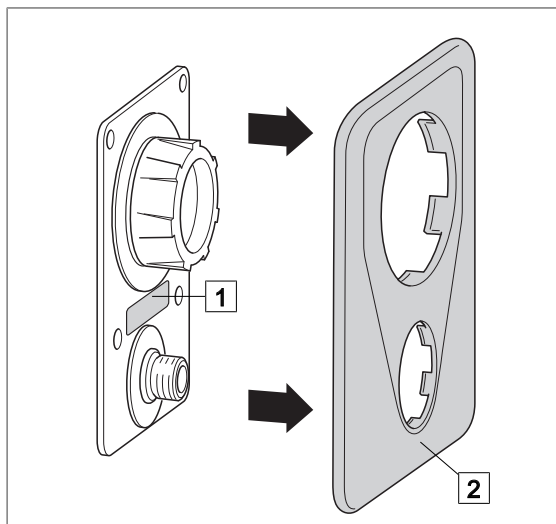

Position of the type plate (1).

Remove the cover (2) to see the type plate.

Fig. 5: Type plate

7.7 Sending in the device

- Remove and properly dispose of consumables.
- Clean and disinfect the product and accessories according to the operating instructions.
- Place used accessories with the product.
- Fill in the form QD 434 „Delivery complaint / return shipment“ and the respective **decontamination certificate**.

This form is enclosed with each delivery and can be found at www.atmosmed.com.

- The device must be well padded and packed in suitable packaging.
- Place the form QD 434 „Delivery complaint / return shipment“ and the respective **decontamination certificate** in an envelope.
- Affix the envelope to the outside of the package.
- Send the product to ATMOS or to your dealer.

8 Technical specifications

8.1 General

Classification as per Appendix IX of the 93/42/EEC Directive	Class IIa
--	-----------

8.2 Technical specifications

Input pressure	300 - 550 kPa* \pm 10%
Measurement range	0 - 15 l/min
Indication accuracy	\pm 10%
Input filter	Sintered metal 60 μ m pore width

* 100 kPa = 1 bar = 1000 mbar = 750 mmHg

8.3 Ambient conditions

Temperature	-40 °C to +60 °C (shipping / storage)
	-20 °C to +60 °C (operation)
Relative humidity	less than 100 % (shipping / storage)
	30 % to 75 % (operation)
Atmospheric pressure	700 hPa to 1060 hPa (shipping / storage)
	700 hPa to 1060 hPa (operation)

8.4 Dimensions and weight

LS FLOW flowmeter installation version	Dimensions: 70 x 100 x 85 mm Weight: 250 g
--	---

9 Approved accessories

The following accessories are not part of the scope of delivery and must be ordered separately:

9.1 Accessories

5752 2745	Adapter for the humidifier
5752 2746	Tube adapter, metal 4 mm, 6 mm, 8 mm
5752 5316	Tube adapter, plastic 4 mm, 6 mm, 8 mm
5750 7525	MEDAP bubble humidifier
5752 5315	Bubble humidifier
5752 5606	Angled adapter

Tab. 6: Accessories

Notes



■ **Manufacturer:**

ATMOS
MedizinTechnik GmbH & Co. KG
Ludwig-Kegel-Str. 16
79853 Lenzkirch
GERMANY
Phone: +49 7653 689-0
www.atmosmed.com